

SIEMENS

SIMATIC

Block library PAC3200 library for SIMATIC WinCC

Function Manual

Introduction

1

Information about the library

2

Description of blocks

3

Configuring guide

4

Technical data

5

Technical Support

6

Legal information

Warning notice system

This manual contains notices you have to observe in order to ensure your personal safety, as well as to prevent damage to property. The notices referring to your personal safety are highlighted in the manual by a safety alert symbol, notices referring only to property damage have no safety alert symbol. These notices shown below are graded according to the degree of danger.

⚠ DANGER
indicates that death or severe personal injury will result if proper precautions are not taken.
⚠ WARNING
indicates that death or severe personal injury may result if proper precautions are not taken.
⚠ CAUTION
with a safety alert symbol, indicates that minor personal injury can result if proper precautions are not taken.
CAUTION
without a safety alert symbol, indicates that property damage can result if proper precautions are not taken.
NOTICE
indicates that an unintended result or situation can occur if the corresponding information is not taken into account.

If more than one degree of danger is present, the warning notice representing the highest degree of danger will be used. A notice warning of injury to persons with a safety alert symbol may also include a warning relating to property damage.

Qualified Personnel

The product/system described in this documentation may be operated only by **personnel qualified** for the specific task in accordance with the relevant documentation for the specific task, in particular its warning notices and safety instructions. Qualified personnel are those who, based on their training and experience, are capable of identifying risks and avoiding potential hazards when working with these products/systems.

Proper use of Siemens products

Note the following:

⚠ WARNING
Siemens products may only be used for the applications described in the catalog and in the relevant technical documentation. If products and components from other manufacturers are used, these must be recommended or approved by Siemens. Proper transport, storage, installation, assembly, commissioning, operation and maintenance are required to ensure that the products operate safely and without any problems. The permissible ambient conditions must be adhered to. The information in the relevant documentation must be observed.

Trademarks

All names identified by ® are registered trademarks of the Siemens AG. The remaining trademarks in this publication may be trademarks whose use by third parties for their own purposes could violate the rights of the owner.

Disclaimer of Liability

We have reviewed the contents of this publication to ensure consistency with the hardware and software described. Since variance cannot be precluded entirely, we cannot guarantee full consistency. However, the information in this publication is reviewed regularly and any necessary corrections are included in subsequent editions.

Table of contents

1	Introduction.....	7
1.1	General	7
1.2	Further documentation.....	8
1.3	Installing the library	8
1.4	Hardware configurations	9
1.5	Configuring in the HW Config	10
2	Information about the library	13
2.1	Overview of the blocks.....	13
2.2	General information about OS typicals	13
2.2.1	Faceplates.....	13
2.2.2	Symbols	15
3	Description of blocks.....	17
3.1	Diagnostic block PAC32DS7	17
3.1.1	Calling OBs	17
3.1.2	Called blocks.....	17
3.1.3	Diagnostic function.....	17
3.1.4	Message behavior.....	18
3.1.5	Error behavior	18
3.1.6	Parameter assignment.....	19
3.1.7	Start-up characteristics	19
3.1.8	Block parameters	19
3.2	PAC32DRV/PAC32300 driver block	20
3.2.1	Calling OBs	20
3.2.2	Called blocks.....	21
3.2.3	Measured value acquisition function.....	21
3.2.4	Message behavior.....	22
3.2.5	Assignment of the cyclic process image.....	28
3.2.6	Parameterization and interconnections	29
3.2.7	Start-up characteristics	29
3.2.8	Processing the diagnostics data of the PAC3200 device	30
3.2.9	Simulation	30
3.2.10	Block parameters	31
3.2.11	Assignment of block parameters to measured variables.....	43
3.2.12	Description of icons and faceplate.....	46
4	Configuring guide.....	65
4.1	Configuring a measuring point.....	65
4.1.1	Creating the S7 program.....	65
4.1.2	Connection to WinCC	70
5	Technical data	73
6	Technical Support.....	75
6.1	Technical Support	75

Index..... 77

Tables

Table 1- 1 Settings required for SENTRON PAC4200.....9
 Table 2- 1 Blocks for S7-400 13
 Table 2- 2 Blocks for S7-300 13
 Table 3- 1 Auxiliary values24
 Table 3- 2 Auxiliary values25
 Table 3- 3 Meanings of the measured variables46
 Table 3- 4 Possible settings of the combination boxes62

Figures

Figure 1-1 Properties of the PAC3200 device directly connected to the DP master system 10
 Figure 1-2 Properties of the PAC3200 device following a Y-link..... 11
 Figure 2-1 Section of the overview display..... 14
 Figure 2-2 Trend setting on the icon..... 15
 Figure 2-3 Icons in Graphics Designer 16
 Figure 3-1 Icon with 3 measured variables46
 Figure 3-2 Icon without measured variables46
 Figure 3-3 Overview faceplate for star connection.....48
 Figure 3-4 Overview faceplate for delta connection49
 Figure 3-5 Current / voltage faceplate for star connection50
 Figure 3-6 Faceplate view current / voltage for delta connection.....52
 Figure 3-7 Power faceplate53
 Figure 3-8 Power factor faceplate54
 Figure 3-9 Energy faceplate55
 Figure 3-10 Total harmonic distortion faceplate56
 Figure 3-11 Current limits faceplate57
 Figure 3-12 Voltage limits faceplate58
 Figure 3-13 Power limits faceplate59
 Figure 3-14 Power factor limits faceplate60
 Figure 3-15 Units faceplate61
 Figure 3-16 Maintenance faceplate.....63
 Figure 4-1 Library in the SIMATIC Manager65
 Figure 4-2 Structure of the sample program66

Figure 4-3	Call of the diagnostic block in OB1	67
Figure 4-4	Call of the driver block in OB35 (S7-400)	68
Figure 4-5	Call of the driver block in OB35 (S7-300)	69
Figure 4-6	Property operator control and monitoring of the DB1	71
Figure 4-7	Link picture component with measuring point.....	72

Introduction

1.1 General

The software package PAC3200 block library for SIMATIC WinCC V1.1 contains the following components:

- Block library with:
 - PAC32DS7: Diagnostic block
 - PAC32DRV / PAC32300: Block for acquiring the measured values of a SENTRON PAC3200
 - PAC42DRV / PAC42300 for the SENTRON PAC4200:
Block for acquiring the measured values of a SENTRON PAC4200
 - Sample program in STL for using the blocks
 - User objects and operating blocks for operating and observing measured data on the WinCC

The block PAC32DRV is intended for use in S7-400, and the block PAC32300 for use in S7-300. The block PAC32DS7 is intended for use in both S7-400 and S7-300. There is no functional difference between the blocks for S7-400 and S7-300.

- Online help in German and English
- Manual in German and English

For details of all WinCC 7 versions supported, refer to the "Readme" file.

A SENTRON PAC4200 can be used instead of SENTRON PAC3200 for more complex measurements.

The block library provides a simple way to make the many different measured variables of a SENTRON PAC3200 available in the SIMATIC environment.

The most important of these 350 variables are output at the block interfaces in the SIMATIC S7 CPU.

They are additionally indicated in SIMATIC WinCC in faceplates and block icons.

SENTRON PAC3200 is integrated in the SIMATIC message, interrupt, and diagnostics concept.

Use options

You can use the block library with the following options:

- SENTRON PAC4200

The block library is based on the functionality of SENTRON PAC3200.

SENTRON PAC4200 can also be used with the block library for complex measurements as an alternative.

- Acyclic connection

Only the most important variables measured with the SENTRON PAC devices require a 112 or 116 byte process image. The "acyclic connection" option is offered for this reason. An acyclic connection is suitable for:

- Simple visualization tasks
- Energy recording

A cyclic connection should be preferred for control tasks because the values are updated with the PROFIBUS DP cycle. Compare basic type 3.

1.2 Further documentation

You can find further details in the following manuals:

- Manual for the SENTRON PAC3200 Power Monitoring Device
- Operating instructions for the SENTRON PAC3200 Power Monitoring Device
- Manual for the PAC PROFIBUS DP expansion module
- Operating instructions for the PAC PROFIBUS DP expansion module
- System Manual for the SENTRON PAC4200 Power Monitoring Device
- Operating instructions for the SENTRON PAC4200 Power Monitoring Device

See also

Internet (<http://support.automation.siemens.com>)

1.3 Installing the library

To start the installation, please insert the CD in the CD-ROM drive on your PG/PC and launch the "install.bat" program. All the other information you need will be provided during the installation process. Please also read the information in the readme file.

1.4 Hardware configurations

The driver concept for PAC3200 allows for operating the SENTRON PAC3200 or SENTRON PAC4200 as a DP slave direct on the DP master system. Operation of PAC3200 following a Y-link in accordance with DPV0 or DPV1 is only allowed for in the S7-400.

- PAC3200 Power Monitoring Devices are integrated via GSD SI018163.gsX.
- PAC4200 Power Monitoring Devices are integrated via GSD SI018173.gsX.

Note

Language-specific GSD files

"X" stands for the language code contained in the file name extension. For more information about the language-specific GSD files, refer to the "SENTRON PAC PROFIBUS DP Expansion Module" manual.

GSD files on the Internet:

(<http://support.automation.siemens.com/WW/view/de/27043677/dl>)

Cyclic connection

The following IO configuration is preset for SENTRON PAC3200 for a cyclic connection:

Inputs:	112 bytes, including 4 bytes for PMD diagnostics and status at slot 1 and 108 bytes for measured values
Outputs:	2 bytes control bytes

This configuration corresponds to **Basic type 3** of PAC3200.

Table 1- 1 Settings required for SENTRON PAC4200

Inputs:	116 bytes, including 4 bytes for PMD diagnostics and status at slot 1 and 112 bytes for measured values
Outputs:	2 bytes control bytes

This configuration corresponds to **basic type 3** on PAC4200.

Acyclic connection

The following IO configuration is preset for SENTRON PAC3200 / PAC4200 for an acyclic connection:

Inputs:	4 bytes for PMD diagnostics and status at slot 1
Outputs:	2 bytes control bytes

An acyclic connection must not be used downstream of a Y-link.

1.5 Configuring in the HW Config

PAC3200 (PAC4200) is integrated in the HW Config according to the above-mentioned options.

Please note that PAC3200 (PAC4200) is implemented in interrupt mode "DPV1" with diagnostic interrupts enabled.

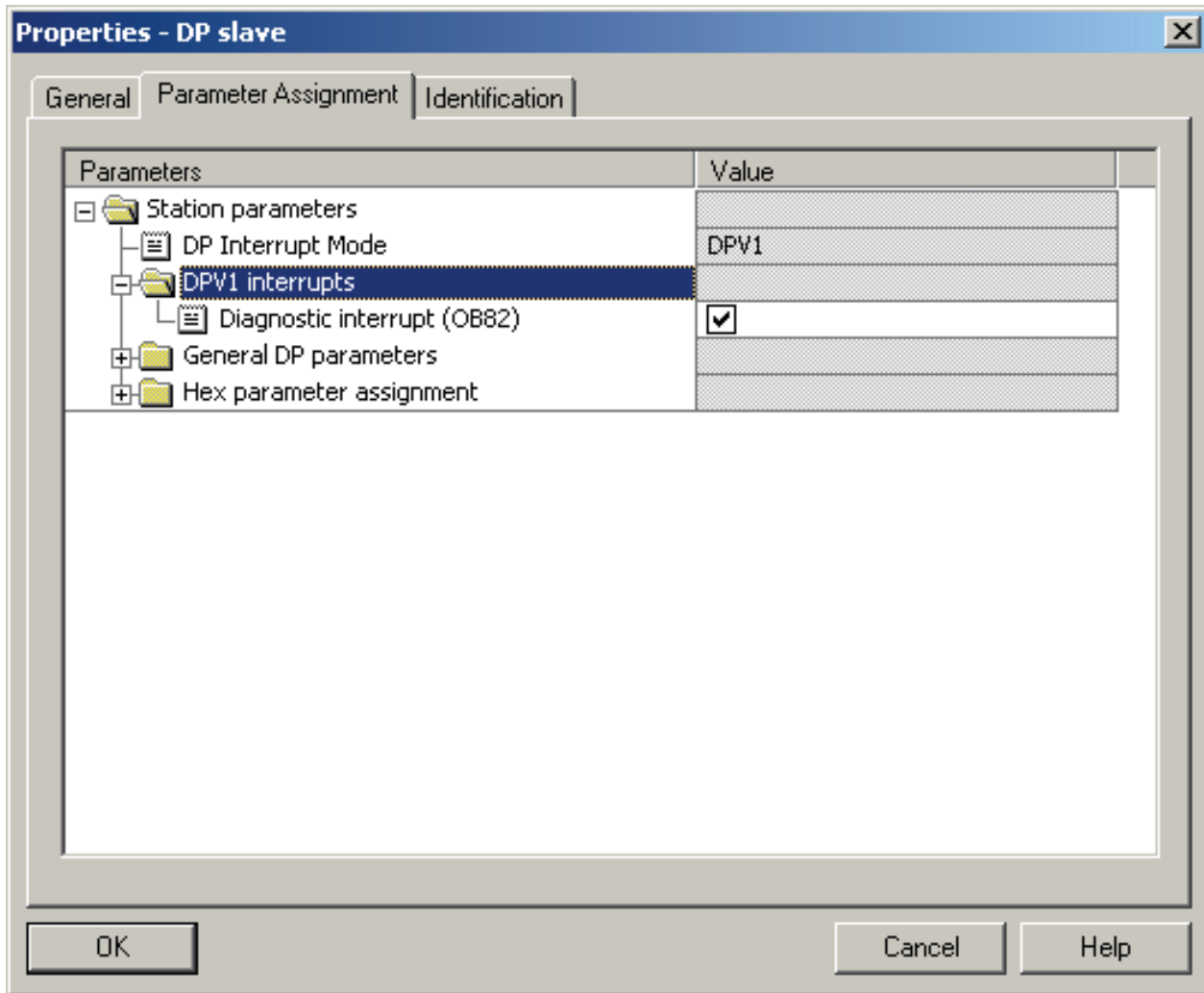

Figure 1-1 Properties of the PAC3200 device directly connected to the DP master system

If PAC3200 (PAC4200) is connected following a Y-link DPV0 or DPV1 (only when used in the S7-400), PAC3200 (PAC4200) must be configured in HW Config as a DPV0 slave. All acyclic services and interrupts are deactivated. This means that the device no longer outputs diagnostic interrupts and data records can no longer be read from the device. For details of the effect this has on the response of the blocks, refer to Section "Description of the blocks (Page 17)".

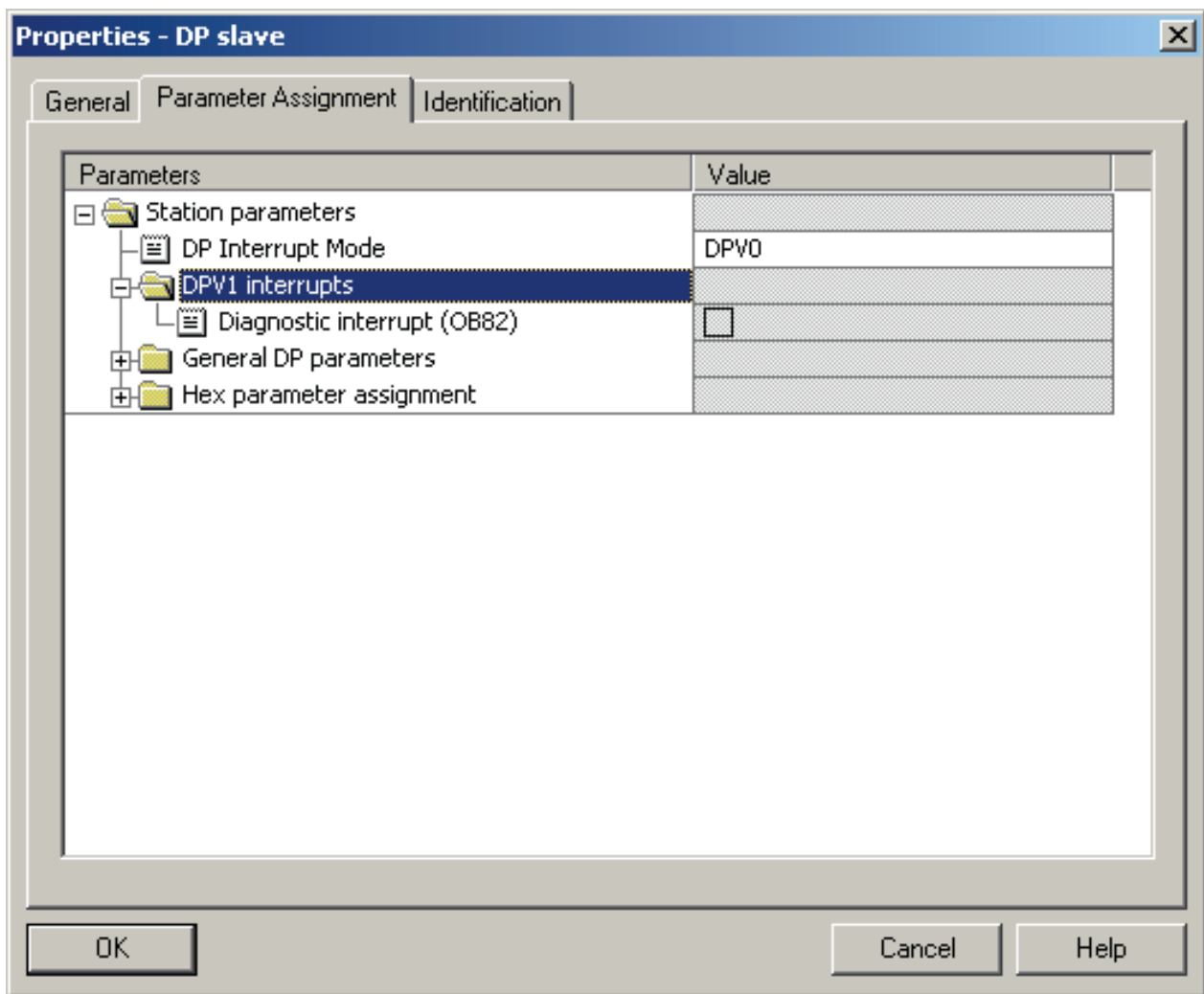

Figure 1-2 Properties of the PAC3200 device following a Y-link

The start addresses of inputs and outputs must be located in the partial process image that is assigned to the watchdog interrupt OB in which the driver block is called.

The assignment of the cyclic interface is included in the description of the driver block.

See also

Assignment of the cyclic process image (Page 28)

Information about the library

2.1 Overview of the blocks

The library contains the following blocks:

Table 2- 1 Blocks for S7-400

Name	Function	Number
PAC32DS7	Diagnostic block	FB180
PAC32DRV	S7-400 driver block for SENTRON PAC3200 for acquiring measured values	FB1081
PAC42DRV	S7-400 driver block for SENTRON PAC4200 for acquiring measured values	FB1082
UDT_DIAG_PAC3200	Data type for diagnostic information	UDT1080
UDT_DIAG_PAC4200	Data type for diagnostic information	UDT1081

Table 2- 2 Blocks for S7-300

Name	Function	Number
PAC32DS7	Diagnostic block	FB180
PAC32300	S7-300 driver block for acquiring measured values	FB181
PAC42300	S7-300 driver block for SENTRON PAC4200 for acquiring measured values	FB182
UDT_DIAG_PAC3200	Data type for diagnostic information	UDT1080
UDT_DIAG_PAC4200	Data type for diagnostic information	UDT1081

The numbers of the FBs can be changed.

Since the UDT is used internally, its number cannot be changed.

2.2 General information about OS typicals

2.2.1 Faceplates

The faceplates are configured with Graphics Designer. If other user objects and functions are required they can be added.

The faceplates described are provided as functional and tested examples and can be adapted by the user.

Two icons and a group/loop display with all the necessary displays are provided for the driver block PAC32DRV / PAC32300. The relevant group display is called using the icons.

Corresponding file names are used for SENTRON PAC4200.

Overview

The display forms part of the
@PG_PAC32DRV_OVERVIEW.PDL / @PG_PAC32300_OVERVIEW.PDL / @PL_PAC32D
RV.PDL / @PL_PAC32300.PDL basic displays.

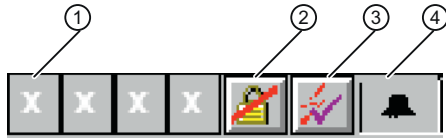

- (1) Group display
- (2) Message lock (MSG_LOCK)
- (3) Message acknowledgment
- (4) Message suppression (QMSG_SUP)

Figure 2-1 Section of the overview display

Trend (@PCS7_PAC32DRV_trend.pdl / @PCS7_PAC32300_trend.pdl)

The "ReturnPath" and "StandardTrend" properties must be parameterized on the icon to incorporate a trend in a faceplate.

- StandardTrend:

2: Online values with 5 min time axis

> 2: Archive values with time axis of the value entered (in min)

- ReturnPath:

.AVGCUR Structural element name starting with a full stop

: Separators

CO_GREEN Color for trend

, Separators between two online values

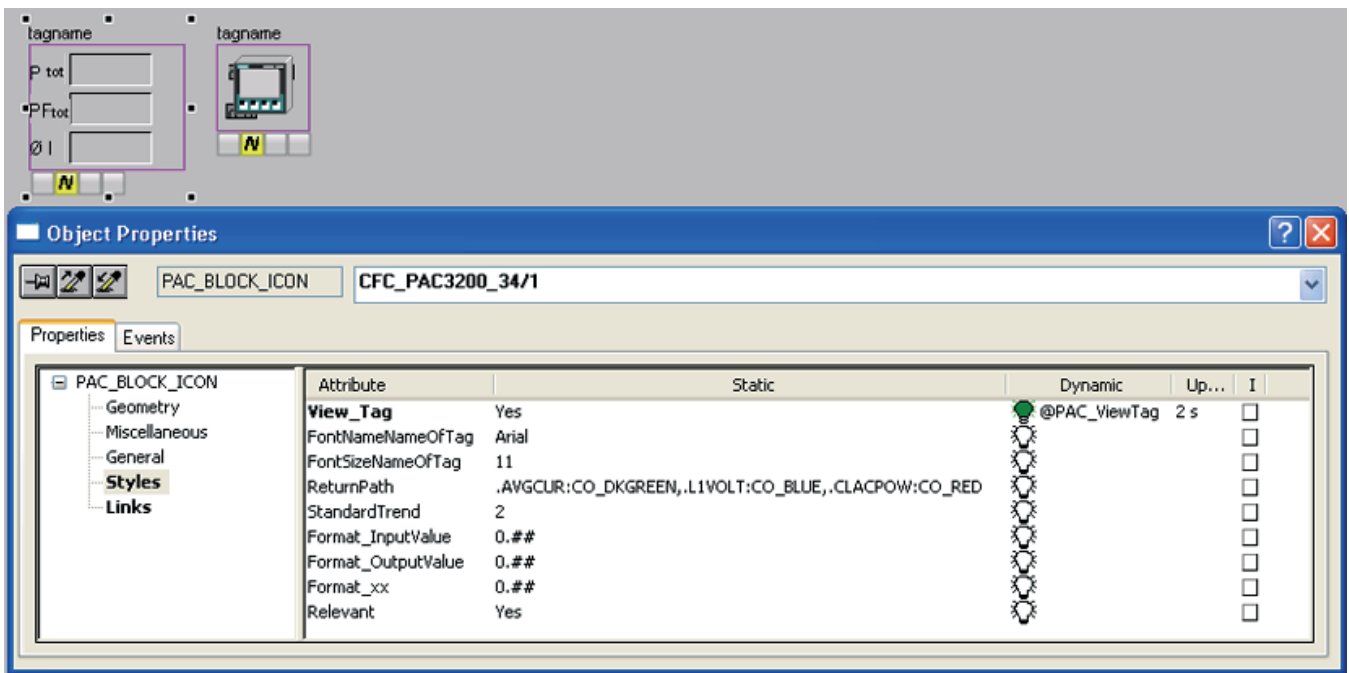

Figure 2-2 Trend setting on the icon

2.2.2 Symbols

The icons are represented as block diagrams.

Template diagram @Template_PAC.pdl

The icons can be found in the template diagram @Template_PAC32DRV.pdl.

To be able to use the "Update Block Icons" function in Graphics Designer, you have to copy the icons of the @Template_PAC32DRV.pdl file into @Template.pdl.

Different variants of block icons

There may be several variants of block icons for one measuring point. These variants are distinguished by the "type" attribute: The value of this attribute describes the variant. There are two symbols for the driver block PAC32DRV / PAC32300. If you look at a variant of the block icon for a measuring point, you will find the value "PAC32DRV/2" / "PAC32300/2" there. You use the part of the value displayed after the "/" to control which variant of the block icon is used.

Connection to the measuring point

The icons are linked to the associated measuring point using the "Connect picture block to measuring point" function.

The icons contain the following visible information:

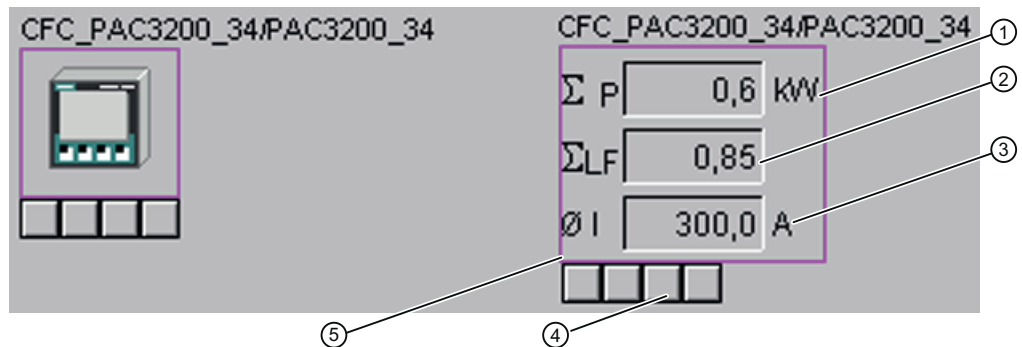

- (1) Total active power
- (2) Total power factor
- (3) Average current out of I_a , I_b , I_c
- (4) Group display (EventState)
- (5) Simulation (QSIM): Magenta

Figure 2-3 Icons in Graphics Designer

Description of blocks

3.1 Diagnostic block PAC32DS7

PAC32DS7 FB180

3.1.1 Calling OBs

The block must be installed in the processing sequence in the following OBs:

OB1 Cyclic program
OB82 Diagnostic interrupt
OB83 Insert/remove module interrupt
OB100 Warm restart

3.1.2 Called blocks

The block calls the following blocks:

SFC6 RD_SINFO
SFC51 RDSYSST

3.1.3 Diagnostic function

The PAC32DS7 block handles the diagnostics of the PAC3200 device and PAC4200 device and checks cyclically for the presence of the device. A scan rate of 20 is implemented in OB1 realisiert so that the diagnostic block is only executed on every 20th call.

Device failure

The diagnostic block PAC32DS7 checks cyclically in OB1 for the presence of the PAC3200 and, if applicable, the PAC4200, and sets the parameter output QRACKF in the case of an error. If this check uncovers an error in the case of SFC51 "RDSYSST", the parameter output SFC_ERR is set and the parameter output SFC_FLT is initialized with the return value of the SFC51 call. If the device is deactivated, the parameter output DEACTIV is set.

If the device is not present, the identifier for "Higher-level fault" (OMODE=16#40xxxxxx) is entered in the parameter output OMODE.

Diagnosics

The block reads the diagnostics information from the PAC3200 if the device has triggered a diagnostic interrupt, and makes the information available at the parameter output QDIAG_INF. The device can only trigger diagnostic interrupts when it is connected direct to the DP master system.

The following diagnostic interrupts can be triggered by the PAC3200:

- Internal communication not ready
- Internal communication is faulty
- Data invalid (CRC error)
- Data invalid (frame error)
- Data invalid (timeout)
- Firmware PAC,Module incompatible
- Invalid value for operating hours counter or universal counter
- Invalid value for energy counter
- Invalid settings for the Power Monitoring Device
- Invalid settings for the limit values
- Voltage out of range
- Current out of range
- Maximum pulse rate exceeded
- A limit value has been violated

See also

Error behavior (Page 18)

3.1.4 Message behavior

The block has no message behavior. The messages in the event of device failure are generated by the driver block PAC32DRV / PAC32300.

3.1.5 Error behavior

See the "Device failure" (Page 17) function.

3.1.6 Parameter assignment

At the parameter input...

- LADDR, the logic start address of the PAC3200 is parameterized.
- DADDR, the diagnostic address of the PAC3200 is parameterized.
- DPA_LINK you determine whether the PAC3200 is operated following a Y link (DPA_LINK = 1 → PAC3200 following a DP / PA link)
- SUBN_TYP you determine whether the PAC3200 is located on an external DP interface such as an IM467 (SUBN_TYP = 1 → DP slave on external DP interface).

3.1.7 Start-up characteristics

In OB100, the identifier for "Start up" is entered for output OMODE (OMODE=16#xx01xxxx).

3.1.8 Block parameters

I/O (parameter)	Comment	Data type	Default	Type	OCM
LADDR	Logical address of module	INT	0	I	—
DADDR	Diagnostic address of module	INT	0	I	—
DPA_LINK	Device connection: 0= DP-MASTER, 1 = DP/PA-LINK	BOOL	FALSE	I	—
SUBN_TYP	1 = External DP interface	BOOL	FALSE	I	—
QERR	1 = Error	BOOL	FALSE	O	—
QRACKF	1 = Device failure	BOOL	FALSE	O	—
DEACTIV	1 = DP slave deactivated	BOOL	FALSE	O	—
SFC_ERR	1 = SFC error	BOOL	FALSE	O	—
SFC_FLT	SFC return value	INT	0	O	—
OMODE	Status MODE	DWORD	0	O	—
QDIAG_INF	Diagnostic information	UDT_DIAG_PAC3200 or UDT-DIAG-PAC4200	—	O	—

Structure of OMODE

Byte	Value	Meaning
Byte 3	16#80: Valid data	—
Byte 2	16#40: Invalid data	Higher-level fault
Byte 1; 0	16#01: Cold restart (OB100)	—

Structure of UDT_DIAG_PAC3200

Byte, bit	Meaning
Byte 0, bit 0	Internal communication not ready
Byte 0, bit 1	Internal communication is faulty
Byte 0, bit 2	Data invalid (CRC error)
Byte 0, bit 3	Data invalid (frame error)
Byte 0, bit 4	Data invalid (timeout)
Byte 0, bit 5	Firmware PAC,Module incompatible
Byte 0, bit 6	Voltage out of range
Byte 0, bit 7	Current out of range
Byte 1, bit 0	Maximum pulse rate exceeded
Byte 1, bit 1	Limit Violations
Byte 1, bit 2	Output not remote operated
Byte 1, bit 3	Invalid value for operating hours counter or universal counter
Byte 1, bit 4	Invalid value for energy counter
Byte 1, bit 5	Invalid settings for the Power Monitoring Device
Byte 1, bit 6	Invalid settings for the limit values
Byte 1, bit 7	Spare

3.2 PAC32DRV/PAC32300 driver block

PAC32DRV	FB1081
PAC32300	FB181
PAC42DRV	FB1082
PAC42300	FB182

3.2.1 Calling OBs

The driver block must be built into a watchdog interrupt OB, e.g. OB32, and additionally in OB100.

3.2.2 Called blocks

PAC32DRV / PAC42DRV

The block calls the following blocks:

SFB35	ALARM_8P
SFB52	RDREC
SFC6	RD_SINFO
SFC20	BLKMOV

PAC32300 / PAC42300

The block calls the following blocks:

SFB52	RDREC
SFC6	RD_SINFO
SFC19	ALARM_SC
SFC20	BLKMOV
SFC107	ALARM_DQ

3.2.3 Measured value acquisition function

The PAC32DRV / PAC32300 (PAC42DRV / PAC42300) block is used for measured value acquisition and it forms the interface to the WinCC.

Measured value acquisition

The block reads measured values from the cyclic process image.

When operating PAC3200 directly on the DP master system, the block also reads the data records with the system function block RDREC (SFB52). The data records contain the maximum and minimum values for current, voltage, power, or power factor and the maximum values for THD-R voltage or THD-R current. Data record 205 contains all of the energy tariffs.

The data records are read in a defined cycle. The interval in which the data records can be read can be set using the input parameter CYCLE_T in seconds. The default setting is 60 seconds. A cycle of 0 seconds or less means that no data records will be read.

Input EN_RDWR can also be used to deactivate the reading of data records (EN_RDWR = 0).

Resetting of measured values

The block can transfer three commands via the cyclic process image. The commands are detected on a rising edge transition of PAC3200 and executed.

The three commands are: reset the minimum values (parameter RESMINVAL = 1), reset the maximum values (parameter RESMAXVAL = 1) and reset the energy counters (parameter RESENERGY = 1).

The parameters RESMINVAL, RESMAXVAL and RESENERGY are reset 10 seconds after the command has been output.

Parameterization of star or delta connection

The input parameter STRDLTCH indicates whether the voltage for a star or delta connection is displayed in the faceplate.

STRDLTCH = 0 indicates star connection, STRDLTCH = 1 indicates delta connection. The default setting is star connection.

3.2.4 Message behavior

PAC32DRV

The PAC32DRV block outputs the following messages via WinCC:

Message block	Message no.	Block parameters	Message text	Message class
MSG_EVID1	1	QAH_L1CUR	Current a alarm high	AH
	2	QAL_L1CUR	Current a alarm low	AL
	3	QWH_L1CUR	Current a warning high	WH
	4	QWL_L1CUR	Current a warning low	WL
	5	QAH_L2CUR	Current b alarm high	AH
	6	QAL_L2CUR	Current b alarm low	AL
	7	QWH_L2CUR	Current b warning high	WH
	8	QWL_L2CUR	Current b warning low	WL
MSG_EVID2	1	QAH_L3CUR	Current c alarm high	AH
	2	QAL_L3CUR	Current c alarm low	AL
	3	QWH_L3CUR	Current c warning high	WH
	4	QWL_L3CUR	Current c warning low	WL
	5	QAH_L1VOLT	Voltage a alarm high	AH
	6	QAL_L1VOLT	Voltage a alarm low	AL
	7	QWH_L1VOLT	Voltage a warning high	WH
	8	QWL_L1VOLT	Voltage a warning low	WL

Message block	Message no.	Block parameters	Message text	Message class
MSG_EVID3	1	QAH_L2VOLT	Voltage b alarm high	AH
	2	QAL_L2VOLT	Voltage b alarm low	AL
	3	QWH_L2VOLT	Voltage b warning high	WH
	4	QWL_L2VOLT	Voltage b warning low	WL
	5	QAH_L3VOLT	Voltage c alarm high	AH
	6	QAL_L3VOLT	Voltage c alarm low	AL
	7	QWH_L3VOLT	Voltage c warning high	WH
	8	QWL_L3VOLT	Voltage c warning low	WL
MSG_EVID4	1	QAH_L12VOLT	Voltage a - b alarm high	AH
	2	QAL_L12VOLT	Voltage a - b alarm low	AL
	3	QWH_L12VOLT	Voltage a - b warning high	WH
	4	QWL_L12VOLT	Voltage a - b warning low	WL
	5	QAH_L23VOLT	Voltage b - c alarm high	AH
	6	QAL_L23VOLT	Voltage b - c alarm low	AL
	7	QWH_L23VOLT	Voltage b - c warning high	WH
	8	QWL_L23VOLT	Voltage b - c warning low	WL
MSG_EVID5	1	QAH_L31VOLT	Voltage b - c alarm high	AH
	2	QAL_L31VOLT	Voltage c - a alarm low	AL
	3	QWH_L31VOLT	Voltage c - a warning high	WH
	4	QWL_L31VOLT	Voltage c - a warning low	WL
	5	QAH_ACPOW	Active power alarm high	AH
	6	QAL_ACPOW	Active power alarm low	AL
	7	QWH_ACPOW	Active power warning high	WH
	8	QWL_ACPOW	Active power warning low	WL
MSG_EVID6	1	QAH_L1POWFA	Power factor a alarm high	AH
	2	QAL_L1POWFA	Power factor a alarm low	AL
	3	QWH_L1POWFA	Power factor a warning high	WH
	4	QWL_L1POWFA	Power factor a warning low	WL
	5	QAH_L2POWFA	Power factor b alarm high	AH
	6	QAL_L2POWFA	Power factor b alarm low	AL
	7	QWH_L2POWFA	Power factor b warning high	WH
	8	QWL_L2POWFA	Power factor b warning low	WL
MSG_EVID7	1	QAH_L3POWFA	Power factor c alarm high	AH
	2	QAL_L3POWFA	Power factor c alarm low	AL
	3	QWH_L3POWFA	Power factor c warning high	WH
	4	QWL_L3POWFA	Power factor c warning low	WL
	5	QAH_CLPOWFA	Collective power factor alarm high	AH
	6	QAL_CLPOWFA	Collective power factor alarm low	AL
	7	QWH_CLPOWFA	Collective power factor warning high	WH
	8	QWL_CLPOWFA	Collective power factor warning low	WL

Message block	Message no.	Block parameters	Message text	Message class
MSG_EVID8	1	QE_COMNRDY	Internal communication not ready	PLC pr ctrl error
	2	QE_COMFAIL	Internal communication is faulty	PLC pr ctrl error
	3	QE_CRCER	Data invalid (CRC error)	PLC pr ctrl error
	4	QE_FRMER	Data invalid (frame error)	PLC pr ctrl error
	5	QE_TIMEOUT	Data invalid (timeout)	PLC pr ctrl error
	6	QE_FMMISMCH	Firmware PAC,Module incompatible	PLC pr ctrl error
	7	QE_VOLTOWER	Voltage out of range	PLC pr ctrl error
	8	QE_CUOVER	Current out of range	PLC pr ctrl error
MSG_EVID9	1	QE_PULSOVER	Maximum pulse rate exceeded	PLC pr ctrl error
	2	QE_LIMVIOL	Limit Violations	PLC pr ctrl error
	3	QE_OUTNORE	Output not remote operated	PLC pr ctrl error
	4	QE_INVLWORK	Invalid value for operating hours counter or universal counter	PLC pr ctrl error
	5	QE_INVLENER	Invalid value for energy counter	PLC pr ctrl error
	6	QE_INPRMMET	Invalid settings for the Power Monitoring Device	PLC pr ctrl error
	7	QE_INPRMLIM	Invalid settings for the limit values	PLC pr ctrl error
	8	RACKF	Device fault: @1%d@	PLC pr ctrl error

Table 3- 1 Auxiliary values

EV_ID	Auxiliary value	Block parameters
MSG_EVID1 ... MSG_EVID8	1	AUX_PR01
	2	AUX_PR02
	3	AUX_PR03
	4	AUX_PR04
	5	AUX_PR05
	6	AUX_PR06
	7	AUX_PR07
	8	AUX_PR08
	9	AUX_PR09
	10	AUX_PR10

EV_ID	Auxiliary value	Block parameters
MSG_EVID9	1	RACK_NO
	2	AUX_PR02
	3	AUX_PR03
	4	AUX_PR04
	5	AUX_PR05
	6	AUX_PR06
	7	AUX_PR07
	8	AUX_PR08
	9	AUX_PR09
	10	AUX_PR10

PAC32300

The PAC32300 block outputs the following messages via WinCC:

Message block	Message number	Block parameters	Message text	Message class
MSG_EVID1	1	—	Alarm@1%d@	AH
MSG_EVID2	1	—	Alarm@1%d@	AH
MSG_EVID3	1	—	Warning@1%d@	WH
MSG_EVID4	1	—	Warning@1%d@	WH
MSG_EVID5	1	QRACKF	Device fault: @1%d@	PLC pr ctrl error
MSG_EVID6	1	—	Diagnostic interrupt @1%x@	PLC pr ctrl error

Table 3-2 Auxiliary values

EV_ID	Auxiliary value	Block parameters
MSG_EVID1	Number of the violated measured variable	See below
MSG_EVID2	Number of the violated measured variable	See below
MSG_EVID3	Number of the violated measured variable	See below
MSG_EVID4	Number of the violated measured variable	See below
MSG_EVID5	Profibus address	RACK_NO
MSG_EVID6	Bitcode of pending diagnostic interrupts	See below

Number of the violated measured variables

The numbers and meanings of the violated measured variables are listed below.

No.	Description	Block parameters
1	Current a (alarm) limit high violated	QAH_L1CUR
4	Current a (alarm) limit low violated	QAL_L1CUR
1	Current a warning limit high violated	QWH_L1CUR
4	Current a warning limit low violated	QWL_L1CUR

3.2 PAC32DRV/PAC32300 driver block

No.	Description	Block parameters
2	Current b (alarm) limit high violated	QAH_L2CUR
5	Current b (alarm) limit low violated	QAL_L2CUR
2	Current b warning limit high violated	QWH_L2CUR
5	Current b warning limit low violated	QWL_L2CUR
3	Current b (alarm) limit high violated	QAH_L3CUR
6	Current b (alarm) limit low violated	QAL_L3CUR
3	Current b warning limit high violated	QWH_L3CUR
6	Current b warning limit low violated	QWL_L3CUR
10	Voltage a (alarm) limit high violated	QAH_L1VOLT
16	Voltage a (alarm) limit low violated	QAL_L1VOLT
10	Voltage a warning limit high violated	QWH_L1VOLT
16	Voltage a warning limit low violated	QWL_L1VOLT
11	Voltage b (alarm) limit high violated	QAH_L2VOLT
17	Voltage b (alarm) limit low violated	QAL_L2VOLT
11	Voltage b warning limit high violated	QWH_L2VOLT
17	Voltage b warning limit low violated	QWL_L2VOLT
12	Voltage c (alarm) limit high violated	QAH_L3VOLT
18	Voltage c (alarm) limit low violated	QAL_L3VOLT
12	Voltage c warning limit high violated	QWH_L3VOLT
18	Voltage c warning limit low violated	QWL_L3VOLT
7	Voltage a - b (alarm) limit high violated	QAH_L12VOLT
13	Voltage a - b (alarm) limit low violated	QAL_L12VOLT
7	Voltage a - b warning limit high violated	QWH_L12VOLT
13	Voltage a - b warning limit low violated	QWL_L12VOLT
8	Voltage b - c (alarm) limit high violated	QAH_L23VOLT
14	Voltage b - c (alarm) limit low violated	QAL_L23VOLT
8	Voltage b - c warning limit high violated	QWH_L23VOLT
14	Voltage b - c warning limit low violated	QWL_L23VOLT
9	Voltage c - a (alarm) limit high violated	QAH_L31VOLT
15	Voltage c - a (alarm) limit low violated	QAL_L31VOLT
9	Voltage c - a warning limit high violated	QWH_L31VOLT
15	Voltage c - a warning limit low violated	QWL_L31VOLT
19	Active power (alarm) limit high violated	QAH_ACPOW
20	Active power (alarm) limit low violated	QAL_ACPOW
19	Active power warning limit high violated	QWH_ACPOW
20	Active power warning limit low violated	QWL_ACPOW
21	Power factor a (alarm) limit high	QAH_L1POWFA
25	Power factor a (alarm) limit low	QAL_L1POWFA
21	Power factor a warning limit high violated	QWH_L1POWFA
25	Power factor a warning limit low violated	QWL_L1POWFA
22	Power factor b (alarm) limit high	QAH_L2POWFA
26	Power factor b (alarm) limit low	QAL_L2POWFA

No.	Description	Block parameters
22	Power factor b warning limit high violated	QWH_L2POWFA
26	Power factor b warning limit low violated	QWL_L2POWFA
23	Power factor c (alarm) limit high	QAH_L3POWFA
27	Power factor c (alarm) limit low	QAL_L3POWFA
23	Power factor c warning limit high violated	QWH_L3POWFA
27	Power factor c warning limit low violated	QWL_L3POWFA
24	Total power factor (alarm) limit high violated	QAH_CLPOWFA
28	Total power factor (alarm) limit low violated	QAL_CLPOWFA
24	Total power factor warning limit high violated	QWH_CLPOWFA
28	Total power factor warning limit low violated	QWL_CLPOWFA

If more than 2 measured values violate an (alarm) limit or warning limit simultaneously, no more messages are sent after the 3rd limit violation. A limit violation can then only be reported again when at least one alarm or warning has gone.

Bitcode of pending diagnostic interrupts

The bitcodes of the pending diagnostic interrupts are listed with their meanings below.

Bitcode	Description	Block parameters
16#0001	Internal communication not ready	QE_COMNRDY
16#0002	Internal communication is faulty	QE_COMFAIL
16#0004	Data invalid (CRC error)	QE_CRCER
16#0008	Data invalid (frame error)	QE_FRMER
16#0010	Data invalid (timeout)	QE_TIMEOUT
16#0020	Firmware PAC,Module incompatible	QE_FMMISMCH
16#0040	Voltage out of range	QE_VOLTOWER
16#0080	Current out of range	QE_CUOVER
16#0100	Maximum pulse rate exceeded	QE_PULSOVER
16#0200	Limit Violations	QE_LIMVIOL
16#0400	Output not remote operated	QE_OUTNORE
16#0800	Invalid value for operating hours counter or universal counter	QE_INVLWORK
16#1000	Invalid value for energy counter	QE_INVLENER
16#2000	Invalid settings for the Power Monitoring Device	QE_INPRMMET
16#4000	Invalid settings for the limit values	QE_INPRMLIM

If several diagnostic interrupts are pending simultaneously, the bitcodes are combined with each other. If, for example, the diagnostic interrupts "Invalid value for energy counter", "Invalid settings for the Power Monitoring Device" and "Invalid settings for the limit values" are pending, this results in the bitcode 16#7000.

3.2.5 Assignment of the cyclic process image

Cyclic connection

A cyclic connection only supports basic type 3.

Name	PAC3200 inputs	PAC4200 inputs	Outputs
Control bytes	—	—	2
PMD diagnostics and status	4	4	—
Voltage V_{a-n}	4	4	—
Voltage V_{b-n}	4	4	—
Voltage V_{c-n}	4	4	—
Voltage V_{a-b}	4	4	—
Voltage V_{b-c}	4	4	—
Voltage V_{c-a}	4	4	—
Current a	4	4	—
Current b	4	4	—
Current c	4	4	—
Power factor a	4	4	—
Power factor b	4	4	—
Power factor c	4	4	—
THD-R voltage a	4	4	—
THD-R voltage b	4	4	—
THD-R voltage c	4	4	—
THD-R current a	4	4	—
THD-R current b	4	4	—
THD-R current c	4	4	—
Frequency	4	4	—
Average current	4	4	—
Total apparent power	4	4	—
Total active power	4	4	—
Total active power	4	4	—
Total power factor	4	4	—
Amplitude unbalance - Voltage	4	4	—
Amplitude unbalance - Current	4	4	—
Demand period	4	4	—
Neutral current	—	4	—
Number of bytes	112	116	2

Acyclic connection

The following are used for an acyclic connection:

- Digital inputs
- Digital outputs
- Device diagnostics
- Device status

Name	PAC3200 inputs	PAC4200 inputs	Outputs
Control bytes	—	—	2
PMD diagnostics and status	4	4	—
Number of bytes:	4	4	2

See also

Configuring in the HW Config (Page 10)

3.2.6 Parameterization and interconnections

At the parameter input...

- RACK_NO, the rack number (PROFIBUS address) of the PAC3200 is parameterized.
- BASADR, the start address of the PAC3200 is parameterized.
- DPA_LINK you determine whether the PAC3200 is operated following a Y link (DPA_LINK = 1 → PAC3200 following a DP / PA link, parameter only present at the PAC32DRV block)

The parameter input...

- MODE is interconnected with the output OMODE of the diagnostic block PAC32DS7.
- RACKF is interconnected with the output QRACKF of the diagnostic block PAC32DS7.
- DIAG_INF is interconnected with the output QDIAG_INF of the diagnostic block PAC32DS7.

The parameter output O_01 is connected to the start output address of the PAC3200.

3.2.7 Start-up characteristics

On starting, messages are deactivated (OB100).

3.2.8 Processing the diagnostics data of the PAC3200 device

If PAC3200 is directly connected to the DP master system, the block processes the diagnostic information that is supplied to it from diagnostics block PAC32DS7 via the input DIAG_INF.

When PAC3200 is connected following a Y-link, the driver block evaluates the device diagnostics and device status from the process image of the inputs.

3.2.9 Simulation

Block input SIM_ON is used to switch driver block PAC32DRV / PAC32300 to simulation mode. In simulation mode, measured values are not read from the PAC3200 device, neither through the cyclic process image nor from a data record.

Instead of this, the following inputs are used as simulated measured values:

I/O (parameter)	Meaning	Data type	Default	Type	OCM
SIM_CUR	Simulated current value	REAL	300.0	I	—
SIM_VOLT	Simulated voltage value	REAL	400.0	I	—
SIM_POW	Simulated power value	REAL	600.0	I	—
SIM_POWFAC	Simulated power factor value	REAL	0.85	I	—
SIM_DW1ENER	Simulated DWORD1 energy value	DWORD	0	I	—
SIM_DW2ENER	Simulated DWORD2 energy value	DWORD	0	I	—

The following default values are used for all other measured values, maximum values or minimum values:

Measured value	Default value
Device diagnostics and device status	0
Minimum current	0
Maximum current	100
Minimum voltage (delta connection)	0
Maximum voltage (delta connection)	430
Minimum voltage (star connection)	0
Maximum voltage (star connection)	260
Minimum power	0
Maximum power	600
Minimum power factor	0.7
Maximum power factor	0.9
Amplitude unbalance - Voltage	0.1
Amplitude unbalance - Current	0.1
THD-R current	2.5
THD-R voltage	2.5
Maximum THD-R current	5.0
Maximum THD-R voltage	5.0
Demand period	0

3.2.10 Block parameters

PAC32DRV / PAC42DRV

I/O (parameter)	Comment	Data type	Default	Type	OCM
MODE	Parameter OMODE of PAC32DS7	DWORD	16#8000FFFF	I	—
BASADR	Base address of PAC3200 module	INT	0	I	—
RACK_NO	Rack number	INT	0	I	—
RACK_F	1 = Rack Failure	BOOL	FALSE	I	X
DIAG_INF	Diagnostic information of PAC32DRV	UDT_DIAG_PAC3200	—	I	—
DPA_LINK	Device connection: 0= DP-MASTER, 1 = DP/PA-LINK	BOOL	FALSE	I	X
SIM_ON	1 = Activate simulation	BOOL	FALSE	I	—
SIM_CUR	Simulation value current	REAL	300.0	I	—
SIM_VOLT	Simulation value voltage	REAL	400.0	I	—
SIM_POW	Simulation value power	REAL	600.0	I	—
SIM_POWFAC	Simulation value power factor	REAL	0.85	I	—
SIM_DW1ENER	Simulation value energy DWORD1	DWORD	0	I	—
SIM_DW2ENER	Simulation value energy DWORD2	DWORD	0	I	—
STRDLTCH	1 = Delta connection	BOOL	FALSE	I	x
UNITVOLT	Voltage unit	BYTE	0	I	x
UNITCURRENT	Current unit	BYTE	0	I	x
UNITACPOW	Active power unit	BYTE	0	I	x
UNITAPPOW	Apparent power unit	BYTE	0	I	x
UNITREPOW	Reactive power unit	BYTE	0	I	x
UNITACENER	Active energy unit	BYTE	0	I	x
UNITAPENER	Apparent energy unit	BYTE	0	I	x
UNITREENER	Reactive energy unit	BYTE	0	I	x
SAMPLE_T	Sample time [s]	REAL	0.1	I	—
CYCLE_T	Cycle time of cyclic reading of DRs [s]	REAL	60.0	I	x
RUNUPCYC	Lag: Number of run up cycles	INT	10	I	—
MSG_EVID1	Message ID message block 1	DWORD	0	I	—
MSG_EVID2	Message ID message block 2	DWORD	0	I	—
MSG_EVID3	Message ID message block 3	DWORD	0	I	—
MSG_EVID4	Message ID message block 4	DWORD	0	I	—
MSG_EVID5	Message ID message block 5	DWORD	0	I	—
MSG_EVID6	Message ID message block 6	DWORD	0	I	—
MSG_EVID7	Message ID message block 7	DWORD	0	I	—
MSG_EVID8	Message ID message block 8	DWORD	0	I	—
MSG_EVID9	Message ID message block 9	DWORD	0	I	—
EN_RDWR	1 = Enable read / write record	BOOL	TRUE	I	—
MSG_LOCK	1 = Messages locked	BOOL	FALSE	I	x
CUR_HL	Current high limit	REAL	0.0	I	x

3.2 PAC32DRV/PAC32300 driver block

I/O (parameter)	Comment	Data type	Default	Type	OCM
CUR_HW	Current high warning	REAL	0.0	I	x
CUR_LW	Current low warning	REAL	0.0	I	x
CUR_LL	Current low limit	REAL	0.0	I	x
CUR_HLHS	Current high limit hysteresis	REAL	0.0	I	x
CUR_LLHS	Current low limit hysteresis	REAL	0.0	I	x
VOLT_HL	Voltage high limit	REAL	0.0	I	x
VOLT_HW	Voltage high warning	REAL	0.0	I	x
VOLT_LW	Voltage low warning	REAL	0.0	I	x
VOLT_LL	Voltage low limit	REAL	0.0	I	x
VOLT_HLHS	Voltage high limit hysteresis	REAL	0.0	I	x
VOLT_LLHS	Voltage low limit hysteresis	REAL	0.0	I	x
POWFA_HL	Power factor high limit	REAL	0.0	I	x
POWFA_HW	Power factor high warning	REAL	0.0	I	x
POWFA_LW	Power factor low warning	REAL	0.0	I	x
POWFA_LL	Power factor low limit	REAL	0.0	I	x
POWFA_HLHS	Power factor high limit hysteresis	REAL	0.0	I	x
POWFA_LLHS	Power factor low limit hysteresis	REAL	0.0	I	x
POW_HL	Power high limit	REAL	0.0	I	x
POW_HW	Power high warning	REAL	0.0	I	x
POW_LW	Power low warning	REAL	0.0	I	x
POW_LL	Power low limit	REAL	0.0	I	x
POW_HLHS	Power high limit hysteresis	REAL	0.0	I	x
POW_LLHS	Power low limit hysteresis	REAL	0.0	I	x
RESMINVAL	1 = Reset min. values	BOOL	FALSE	IO	x
RESMAXVAL	1 = Reset max. values	BOOL	FALSE	IO	x
RESENERGY	1 = Reset energy counters	BOOL	FALSE	IO	x
AUX_PR01	Auxiliary value 01	ANY	—	IO	—
AUX_PR02	Auxiliary value 02	ANY	—	IO	—
AUX_PR03	Auxiliary value 03	ANY	—	IO	—
AUX_PR04	Auxiliary value 04	ANY	—	IO	—
AUX_PR05	Auxiliary value 05	ANY	—	IO	—
AUX_PR06	Auxiliary value 06	ANY	—	IO	—
AUX_PR07	Auxiliary value 07	ANY	—	IO	—
AUX_PR08	Auxiliary value 08	ANY	—	IO	—
AUX_PR09	Auxiliary value 09	ANY	—	IO	—
AUX_PR10	Auxiliary value 10	ANY	—	IO	—
QERR	1 = Error	BOOL	FALSE	O	x
QBAD	1 = Bad process value	BOOL	FALSE	O	x
QSIM	1 = Simulation active	BOOL	FALSE	O	x
QAH_L1CUR	1 = Alarm high: Current a	BOOL	FALSE	O	—
QAL_L1CUR	1 = Alarm low: Current a	BOOL	FALSE	O	—
QWH_L1CUR	1 = Warning high: Current a	BOOL	FALSE	O	—

I/O (parameter)	Comment	Data type	Default	Type	OCM
QWL_L1CUR	1 = Warning low: Current a	BOOL	FALSE	O	—
QAH_L2CUR	1 = Alarm high: Current b	BOOL	FALSE	O	—
QAL_L2CUR	1 = Alarm low: Current b	BOOL	FALSE	O	—
QWH_L2CUR	1 = Warning high: Current b	BOOL	FALSE	O	—
QWL_L2CUR	1 = Warning low: Current b	BOOL	FALSE	O	—
QAH_L3CUR	1 = Alarm high: Current c	BOOL	FALSE	O	—
QAL_L3CUR	1 = Alarm low: Current c	BOOL	FALSE	O	—
QWH_L3CUR	1 = Warning high: Current c	BOOL	FALSE	O	—
QWL_L3CUR	1 = Warning low: Current c	BOOL	FALSE	O	—
QAH_L1VOLT	1 = Alarm high: Voltage a	BOOL	FALSE	O	—
QAL_L1VOLT	1 = Alarm low: Voltage a	BOOL	FALSE	O	—
QWH_L1VOLT	1 = Warning high: Voltage a	BOOL	FALSE	O	—
QWL_L1VOLT	1 = Warning low: Voltage a	BOOL	FALSE	O	—
QAH_L2VOLT	1 = Alarm high: Voltage b	BOOL	FALSE	O	—
QAL_L2VOLT	1 = Alarm low: Voltage b	BOOL	FALSE	O	—
QWH_L2VOLT	1 = Warning high: Voltage b	BOOL	FALSE	O	—
QWL_L2VOLT	1 = Warning low: Voltage b	BOOL	FALSE	O	—
QAH_L3VOLT	1 = Alarm high: Voltage c	BOOL	FALSE	O	—
QAL_L3VOLT	1 = Alarm low: Voltage c	BOOL	FALSE	O	—
QWH_L3VOLT	1 = Warning high: Voltage c	BOOL	FALSE	O	—
QWL_L3VOLT	1 = Warning low: Voltage c	BOOL	FALSE	O	—
QAH_L12VOLT	1 = Alarm high: Voltage a - b	BOOL	FALSE	O	—
QAL_L12VOLT	1 = Alarm low: Voltage a - b	BOOL	FALSE	O	—
QWH_L12VOLT	1 = Warning high: Voltage a - b	BOOL	FALSE	O	—
QWL_L12VOLT	1 = Warning low: Voltage a - b	BOOL	FALSE	O	—
QAH_L23VOLT	1 = Alarm high: Voltage b - c	BOOL	FALSE	O	—
QAL_L23VOLT	1 = Alarm low: Voltage b - c	BOOL	FALSE	O	—
QWH_L23VOLT	1 = Warning high: Voltage b - c	BOOL	FALSE	O	—
QWL_L23VOLT	1 = Warning low: Voltage b - c	BOOL	FALSE	O	—
QAH_L31VOLT	1 = Alarm high: Voltage c - a	BOOL	FALSE	O	—
QAL_L31VOLT	1 = Alarm low: Voltage c - a	BOOL	FALSE	O	—
QWH_L31VOLT	1 = Warning high: Voltage c - a	BOOL	FALSE	O	—
QWL_L31VOLT	1 = Warning low: Voltage c - a	BOOL	FALSE	O	—
QAH_ACPOW	1 = Alarm high: Active power	BOOL	FALSE	O	—
QAL_ACPOW	1 = Alarm low: Active power	BOOL	FALSE	O	—
QWH_ACPOW	1 = Warning high: Active power	BOOL	FALSE	O	—
QWL_ACPOW	1 = Warning low: Active power	BOOL	FALSE	O	—
QAH_L1POWFA	1 = Alarm high: Power factor a	BOOL	FALSE	O	—
QAL_L1POWFA	1 = Alarm low: Power factor a	BOOL	FALSE	O	—
QWH_L1POWFA	1 = Warning high: Power factor a	BOOL	FALSE	O	—
QWL_L1POWFA	1 = Warning low: Power factor a	BOOL	FALSE	O	—
QAH_L2POWFA	1 = Alarm high: Power factor b	BOOL	FALSE	O	—

3.2 PAC32DRV/PAC32300 driver block

I/O (parameter)	Comment	Data type	Default	Type	OCM
QAL_L2POWFA	1 = Alarm low: Power factor b	BOOL	FALSE	0	—
QWH_L2POWFA	1 = Warning high: Power factor b	BOOL	FALSE	0	—
QWL_L2POWFA	1 = Warning low: Power factor b	BOOL	FALSE	0	—
QAH_L3POWFA	1 = Alarm high: Power factor c	BOOL	FALSE	0	—
QAL_L3POWFA	1 = Alarm low: Power factor c	BOOL	FALSE	0	—
QWH_L3POWFA	1 = Warning high: Power factor c	BOOL	FALSE	0	—
QWL_L3POWFA	1 = Warning low: Power factor c	BOOL	FALSE	0	—
QAH_CLPOWFA	1 = Alarm high: Collective power factor	BOOL	FALSE	0	—
QAL_CLPOWFA	1 = Alarm low: Collective power factor	BOOL	FALSE	0	—
QWH_CLPOWFA	1 = Warning high: Collective power factor	BOOL	FALSE	0	—
QWL_CLPOWFA	1 = Warning low: Collective power factor	BOOL	FALSE	0	—
QE_COMNRDY	1 = Communication with PAC not ready	BOOL	FALSE	0	x
QE_COMFAIL	1 = Communication with PAC failed	BOOL	FALSE	0	x
QE_CRCER	1 = Data invalid (CRC error)	BOOL	FALSE	0	x
QE_FRMER	1 = Data invalid (Frame error)	BOOL	FALSE	0	x
QE_TIMEOUT	1 = Data invalid (Timeout)	BOOL	FALSE	0	x
QE_FMMISMCH	1 = Firmware mismatch	BOOL	FALSE	0	x
QE_VOLTOVER	1 = Voltage overload	BOOL	FALSE	0	x
QE_CUROVER	1 = Current overload	BOOL	FALSE	0	x
QE_PULSOVER	1 = Pulse output overload	BOOL	FALSE	0	x
QE_LIMVIOL	1 = Limit violations	BOOL	FALSE	0	x
QE_OUTNORE	1 = Outputs not remote operated	BOOL	FALSE	0	x
QE_INVLWORK	1 = Invalid value for work/configurable counter	BOOL	FALSE	0	x
QE_INVLENER	1 = Invalid value for energy counter	BOOL	FALSE	0	x
QE_INPRMMET	1 = Invalid parameter value for metering function	BOOL	FALSE	0	x
QE_INPRMLIM	1 = Invalid parameter value for limit violations	BOOL	FALSE	0	x
QMSG_ERR	1 = Message error	BOOL	FALSE	0	—
QMSG_SUP	1 = Message suppression active	BOOL	FALSE	0	x
MSG_STAT1	Message block 1: STATUS output	WORD	0	0	—
MSG_STAT2	Message block 2: STATUS output	WORD	0	0	—
MSG_STAT3	Message block 3: STATUS output	WORD	0	0	—
MSG_STAT4	Message block 4: STATUS output	WORD	0	0	—
MSG_STAT5	Message block 5: STATUS output	WORD	0	0	—
MSG_STAT6	Message block 6: STATUS output	WORD	0	0	—
MSG_STAT7	Message block 7: STATUS output	WORD	0	0	—
MSG_STAT8	Message block 8: STATUS output	WORD	0	0	—
MSG_STAT9	Message block 9: STATUS output	WORD	0	0	—
MSG_ACK1	Message block 1: ACK_STATE output	WORD	0	0	—
MSG_ACK2	Message block 2: ACK_STATE output	WORD	0	0	—
MSG_ACK3	Message block 3: ACK_STATE output	WORD	0	0	—

I/O (parameter)	Comment	Data type	Default	Type	OCM
MSG_ACK4	Message block 4: ACK_STATE output	WORD	0	O	—
MSG_ACK5	Message block 5: ACK_STATE output	WORD	0	O	—
MSG_ACK6	Message block 6: ACK_STATE output	WORD	0	O	—
MSG_ACK7	Message block 7: ACK_STATE output	WORD	0	O	—
MSG_ACK8	Message block 8: ACK_STATE output	WORD	0	O	—
MSG_ACK9	Message block 9: ACK_STATE output	WORD	0	O	—
L1CUR_LID	Current L1 limit ID	WORD	16#FFFF	O	x
L2CUR_LID	Current L2 limit ID	WORD	16#FFFF	O	x
L3CUR_LID	Current L3 limit ID	WORD	16#FFFF	O	x
L1VOLT_LID	Voltage L1 limit ID	WORD	16#FFFF	O	x
L2VOLT_LID	Voltage L2 limit ID	WORD	16#FFFF	O	x
L3VOLT_LID	Voltage L3 limit ID	WORD	16#FFFF	O	x
ACPOW_LID	Active power limit ID	WORD	16#FFFF	O	x
L1POWFA_LID	Power factor a limit ID	WORD	16#FFFF	O	x
L2POWFA_LID	Power factor b limit ID	WORD	16#FFFF	O	x
L3POWFA_LID	Power factor c limit ID	WORD	16#FFFF	O	x
CLPOWFA_LID	Collective power factor limit ID	WORD	16#FFFF	O	x
QUALITY	Quality code of process value	BYTE	0	O	—
O_01	Control bytes DP 0.0-1.7	WORD	0	O	—
MINVALDATE	Last min. values reset date	STRING[10]	—	O	x
MINVALTIME	Last min. values reset time	STRING[8]	—	O	x
MAXVALDATE	Last max. values reset date	STRING[10]	—	O	x
MAXVALTIME	Last max. values reset time	STRING[8]	—	O	x
ENERGYDATE	Last energy counters reset date	STRING[10]	—	O	x
ENERGYTIME	Last energy counters reset time	STRING[8]	—	O	x
STATDIAG	Device diagnostics and status	DWORD	—	O	x
L1VOLT	Voltage ph - n a	REAL	—	O	x
L2VOLT	Voltage ph - n b	REAL	—	O	x
L3VOLT	Voltage ph - n c	REAL	—	O	x
L12VOLT	Voltage ph - ph, a - b	REAL	—	O	x
L23VOLT	Voltage ph - ph, b - c	REAL	—	O	x
L31VOLT	Voltage ph - ph, c - a	REAL	—	O	x
L1CUR	Current a	REAL	—	O	x
L2CUR	Current b	REAL	—	O	x
L3CUR	Current c	REAL	—	O	x
L1POWFA	Power factor a	REAL	—	O	x
L2POWFA	Power factor b	REAL	—	O	x
L3POWFA	Power factor c	REAL	—	O	x
L1TCUR	THD-R current a	REAL	—	O	x
L2TCUR	THD-R current b	REAL	—	O	x
L3TCUR	THD-R current c	REAL	—	O	x
L1TVOLT	THD-R voltage a	REAL	—	O	x

3.2 PAC32DRV/PAC32300 driver block

I/O (parameter)	Comment	Data type	Default	Type	OCM
L2TVOLT	THD-R voltage b	REAL	—	O	x
L3TVOLT	THD-R voltage c	REAL	—	O	x
FREQUENCY	Frequency	REAL	—	O	x
AVGCUR	Average current	REAL	—	O	x
CLAPPOW	Collective apparent power	REAL	—	O	x
CLACPOW	Collective active power	REAL	—	O	x
CLREPOW	Collective reactive power	REAL	—	O	x
CLPOWFA	Collective power factor	REAL	—	O	x
AMPUVOLT	Amplitude unbalance voltage	REAL	—	O	x
AMPUCUR	Amplitude unbalance current	REAL	—	O	x
RLPPL	Real load profile period length	REAL	—	O	x
MAXL1CUR	Max. current a	REAL	—	O	x
MAXL2CUR	Max. current b	REAL	—	O	x
MAXL3CUR	Max. current c	REAL	—	O	x
MINL1CUR	Min. current a	REAL	—	O	x
MINL2CUR	Min. current b	REAL	—	O	x
MINL3CUR	Min. current c	REAL	—	O	x
MAXL1VOLT	Max. voltage ph - n a	REAL	—	O	x
MAXL2VOLT	Max. voltage ph - n b	REAL	—	O	x
MAXL3VOLT	Max. voltage ph - n c	REAL	—	O	x
MAXL12VOLT	Max. voltage ph - ph, a - b	REAL	—	O	x
MAXL23VOLT	Max. voltage ph - ph, b - c	REAL	—	O	x
MAXL31VOLT	Max. voltage ph - ph, c - a	REAL	—	O	x
MINL1VOLT	Min. voltage ph - n a	REAL	—	O	x
MINL2VOLT	Min. voltage ph - n b	REAL	—	O	x
MINL3VOLT	Min. voltage ph - n c	REAL	—	O	x
MINL12VOLT	Min. voltage ph - ph, a - b	REAL	—	O	x
MINL23VOLT	Min. voltage ph - ph, b - c	REAL	—	O	x
MINL31VOLT	Min. voltage ph - ph, c - a	REAL	—	O	x
MAXL1POWFA	Max. power factor a	REAL	—	O	x
MAXL2POWFA	Max. power factor b	REAL	—	O	x
MAXL3POWFA	Max. power factor c	REAL	—	O	x
MAXCLAPPOW	Max. collective apparent power	REAL	—	O	x
MAXCLACPOW	Max. collective active power	REAL	—	O	x
MAXCLREPOW	Max. collective reactive power	REAL	—	O	x
MINL1POWFA	Min. power factor a	REAL	—	O	x
MINL2POWFA	Min. power factor b	REAL	—	O	x
MINL3POWFA	Min. power factor c	REAL	—	O	x
MINCLAPPOW	Min. collective apparent power	REAL	—	O	x
MINCLACPOW	Min. collective active power	REAL	—	O	x
MINCLREPOW	Min. collective reactive power	REAL	—	O	x
MAXL1TVOLT	Max. THD-R voltage a	REAL	—	O	x

I/O (parameter)	Comment	Data type	Default	Type	OCM
MAXL2TVOLT	Max. THD-R voltage b	REAL	—	O	x
MAXL3TVOLT	Max. THD-R voltage c	REAL	—	O	x
MAXL1TCUR	Max. THD-R current a	REAL	—	O	x
MAXL2TCUR	Max. THD-R current b	REAL	—	O	x
MAXL3TCUR	Max. THD-R current c	REAL	—	O	x
AEIT1DW1	Active energy import tariff 1 DWORD1	DWORD	—	O	x
AEIT1DW2	Active energy import tariff 1 DWORD2	DWORD	—	O	x
AEIT2DW1	Active energy import tariff 2 DWORD1	DWORD	—	O	x
AEIT2DW2	Active energy import tariff 2 DWORD2	DWORD	—	O	x
AEET1DW1	Active energy export tariff 1 DWORD1	DWORD	—	O	x
AEET1DW2	Active energy export tariff 1 DWORD2	DWORD	—	O	x
AEET2DW1	Active energy export tariff 2 DWORD1	DWORD	—	O	x
AEET2DW2	Active energy export tariff 2 DWORD2	DWORD	—	O	x
REIT1DW1	Reactive energy import tariff 1 DWORD1	DWORD	—	O	x
REIT1DW2	Reactive energy import tariff 1 DWORD2	DWORD	—	O	x
REIT2DW1	Reactive energy import tariff 2 DWORD1	DWORD	—	O	x
REIT2DW2	Reactive energy import tariff 2 DWORD2	DWORD	—	O	x
REET1DW1	Reactive energy export tariff 1 DWORD1	DWORD	—	O	x
REET1DW2	Reactive energy export tariff 1 DWORD2	DWORD	—	O	x
REET2DW1	Reactive energy export tariff 2 DWORD1	DWORD	—	O	x
REET2DW2	Reactive energy export tariff 2 DWORD2	DWORD	—	O	x
AET1DW1	Apparent energy tariff 1 DWORD1	DWORD	—	O	x
AET1DW2	Apparent energy tariff 1 DWORD2	DWORD	—	O	x
AET2DW1	Apparent energy tariff 2 DWORD1	DWORD	—	O	x
AET2DW2	Apparent energy tariff 2 DWORD2	DWORD	—	O	x

PAC32300 / PAC42300

I/O (parameter)	Comment	Data type	Default	Type	OCM
MODE	Parameter OMODE of PAC32DIA or PAC32DS7	DWORD	16#8000FFFF	I	—
BASADR	Base address of PAC3200 module	INT	0	I	—
RACK_NO	Rack number	INT	0	I	—
RACKF	1 = Rack Failure	BOOL	FALSE	I	X
DIAG_INF	Diagnostic information of PAC32DRV	UDT_DIAG_PAC3200	—	I	—
SIM_ON	1 = Activate simulation	BOOL	FALSE	I	—
SIM_CUR	Simulation value current	REAL	300.0	I	—
SIM_VOLT	Simulation value voltage	REAL	400.0	I	—
SIM_POW	Simulation value power	REAL	600.0	I	—
SIM_POWFAC	Simulation value power factor	REAL	0.85	I	—
SIM_DW1ENER	Simulation value energy DWORD1	DWORD	0	I	—
SIM_DW2ENER	Simulation value energy DWORD2	DWORD	0	I	—

I/O (parameter)	Comment	Data type	Default	Type	OCM
STRDLTCH	1 = Delta connection	BOOL	FALSE		x
UNITVOLT	Voltage unit	BYTE	0		x
UNITCURRENT	Current unit	BYTE	0		x
UNITACPOW	Active power unit	BYTE	0		x
UNITAPPOW	Apparent power unit	BYTE	0		x
UNITREPOW	Reactive power unit	BYTE	0		x
UNITACENER	Active energy unit	BYTE	0		x
UNITAPENER	Apparent energy unit	BYTE	0		x
UNITREENER	Reactive energy unit	BYTE	0		x
SAMPLE_T	Sample time [s]	REAL	0.1		—
CYCLE_T	Cycle time of cyclic reading of DRs [s]	REAL	60.0		x
RUNUPCYC	Lag: Number of run up cycles	INT	10		—
MSG_EVID1	Message ID message block 1	DWORD	0		—
MSG_EVID2	Message ID message block 2	DWORD	0		—
MSG_EVID3	Message ID message block 3	DWORD	0		—
MSG_EVID4	Message ID message block 4	DWORD	0		—
MSG_EVID5	Message ID message block 5	DWORD	0		—
MSG_EVID6	Message ID message block 6	DWORD	0		—
CMP_ID	Component ID	DWORD	16#00000001		—
EN_RDWR	1= Enable read / write record	BOOL	TRUE		—
MSG_LOCK	1 = Messages locked	BOOL	FALSE		x
CUR_HL	Current high limit	REAL	0.0		x
CUR_HW	Current high warning	REAL	0.0		x
CUR_LW	Current low warning	REAL	0.0		x
CUR_LL	Current low limit	REAL	0.0		x
CUR_HLHS	Current high limit hysteresis	REAL	0.0		x
CUR_LLHS	Current low limit hysteresis	REAL	0.0		x
VOLT_HL	Voltage high limit	REAL	0.0		x
VOLT_HW	Voltage high warning	REAL	0.0		x
VOLT_LW	Voltage low warning	REAL	0.0		x
VOLT_LL	Voltage low limit	REAL	0.0		x
VOLT_HLHS	Voltage high limit hysteresis	REAL	0.0		x
VOLT_LLHS	Voltage low limit hysteresis	REAL	0.0		x
POWFA_HL	Power factor high limit	REAL	0.0		x
POWFA_HW	Power factor high warning	REAL	0.0		x
POWFA_LW	Power factor low warning	REAL	0.0		x
POWFA_LL	Power factor low limit	REAL	0.0		x
POWFA_HLHS	Power factor high limit hysteresis	REAL	0.0		x
POWFA_LLHS	Power factor low limit hysteresis	REAL	0.0		x
POW_HL	Power high limit	REAL	0.0		x
POW_HW	Power high warning	REAL	0.0		x
POW_LW	Power low warning	REAL	0.0		x

I/O (parameter)	Comment	Data type	Default	Type	OCM
POW_LL	Power low limit	REAL	0.0	I	x
POW_HLHS	Power high limit hysteresis	REAL	0.0	I	x
POW_LLHS	Power low limit hysteresis	REAL	0.0	I	x
RESMINVAL	1 = Reset min. values	BOOL	FALSE	IO	x
RESMAXVAL	1 = Reset max. values	BOOL	FALSE	IO	x
RESENERGY	1 = Reset energy counters	BOOL	FALSE	IO	x
QERR	1 = Error	BOOL	FALSE	O	x
QBAD	1 = Bad process value	BOOL	FALSE	O	x
QRACKF	1 = Device failure	BOOL	FALSE	O	x
QSIM	1 = Simulation active	BOOL	FALSE	O	x
QAH_L1CUR	1 = Alarm high: Current a	BOOL	FALSE	O	—
QAL_L1CUR	1 = Alarm low: Current a	BOOL	FALSE	O	—
QWH_L1CUR	1 = Warning high: Current a	BOOL	FALSE	O	—
QWL_L1CUR	1 = Warning low: Current a	BOOL	FALSE	O	—
QAH_L2CUR	1 = Alarm high: Current b	BOOL	FALSE	O	—
QAL_L2CUR	1 = Alarm low: Current b	BOOL	FALSE	O	—
QWH_L2CUR	1 = Warning high: Current b	BOOL	FALSE	O	—
QWL_L2CUR	1 = Warning low: Current b	BOOL	FALSE	O	—
QAH_L3CUR	1 = Alarm high: Current c	BOOL	FALSE	O	—
QAL_L3CUR	1 = Alarm low: Current c	BOOL	FALSE	O	—
QWH_L3CUR	1 = Warning high: Current c	BOOL	FALSE	O	—
QWL_L3CUR	1 = Warning low: Current c	BOOL	FALSE	O	—
QAH_L1VOLT	1 = Alarm high: Voltage a	BOOL	FALSE	O	—
QAL_L1VOLT	1 = Alarm low: Voltage a	BOOL	FALSE	O	—
QWH_L1VOLT	1 = Warning high: Voltage a	BOOL	FALSE	O	—
QWL_L1VOLT	1 = Warning low: Voltage a	BOOL	FALSE	O	—
QAH_L2VOLT	1 = Alarm high: Voltage b	BOOL	FALSE	O	—
QAL_L2VOLT	1 = Alarm low: Voltage b	BOOL	FALSE	O	—
QWH_L2VOLT	1 = Warning high: Voltage b	BOOL	FALSE	O	—
QWL_L2VOLT	1 = Warning low: Voltage b	BOOL	FALSE	O	—
QAH_L3VOLT	1 = Alarm high: Voltage c	BOOL	FALSE	O	—
QAL_L3VOLT	1 = Alarm low: Voltage c	BOOL	FALSE	O	—
QWH_L3VOLT	1 = Warning high: Voltage c	BOOL	FALSE	O	—
QWL_L3VOLT	1 = Warning low: Voltage c	BOOL	FALSE	O	—
QAH_L12VOLT	1 = Alarm high: Voltage a - b	BOOL	FALSE	O	—
QAL_L12VOLT	1 = Alarm low: Voltage a - b	BOOL	FALSE	O	—
QWH_L12VOLT	1 = Warning high: Voltage a - b	BOOL	FALSE	O	—
QWL_L12VOLT	1 = Warning low: Voltage a - b	BOOL	FALSE	O	—
QAH_L23VOLT	1 = Alarm high: Voltage b - c	BOOL	FALSE	O	—
QAL_L23VOLT	1 = Alarm low: Voltage b - c	BOOL	FALSE	O	—
QWH_L23VOLT	1 = Warning high: Voltage b - c	BOOL	FALSE	O	—
QWL_L23VOLT	1 = Warning low: Voltage b - c	BOOL	FALSE	O	—

3.2 PAC32DRV/PAC32300 driver block

I/O (parameter)	Comment	Data type	Default	Type	OCM
QAH_L31VOLT	1 = Alarm high: Voltage c - a	BOOL	FALSE	0	—
QAL_L31VOLT	1 = Alarm low: Voltage c - a	BOOL	FALSE	0	—
QWH_L31VOLT	1 = Warning high: Voltage c - a	BOOL	FALSE	0	—
QWL_L31VOLT	1 = Warning low: Voltage c - a	BOOL	FALSE	0	—
QAH_ACPOW	1 = Alarm high: Active power	BOOL	FALSE	0	—
QAL_ACPOW	1 = Alarm low: Active power	BOOL	FALSE	0	—
QWH_ACPOW	1 = Warning high: Active power	BOOL	FALSE	0	—
QWL_ACPOW	1 = Warning low: Active power	BOOL	FALSE	0	—
QAH_L1POWFA	1 = Alarm high: Power factor a	BOOL	FALSE	0	—
QAL_L1POWFA	1 = Alarm low: Power factor a	BOOL	FALSE	0	—
QWH_L1POWFA	1 = Warning high: Power factor a	BOOL	FALSE	0	—
QWL_L1POWFA	1 = Warning low: Power factor a	BOOL	FALSE	0	—
QAH_L2POWFA	1 = Alarm high: Power factor b	BOOL	FALSE	0	—
QAL_L2POWFA	1 = Alarm low: Power factor b	BOOL	FALSE	0	—
QWH_L2POWFA	1 = Warning high: Power factor b	BOOL	FALSE	0	—
QWL_L2POWFA	1 = Warning low: Power factor b	BOOL	FALSE	0	—
QAH_L3POWFA	1 = Alarm high: Power factor c	BOOL	FALSE	0	—
QAL_L3POWFA	1 = Alarm low: Power factor c	BOOL	FALSE	0	—
QWH_L3POWFA	1 = Warning high: Power factor c	BOOL	FALSE	0	—
QWL_L3POWFA	1 = Warning low: Power factor c	BOOL	FALSE	0	—
QAH_CLPOWFA	1 = Alarm high: Collective power factor	BOOL	FALSE	0	—
QAL_CLPOWFA	1 = Alarm low: Collective power factor	BOOL	FALSE	0	—
QWH_CLPOWFA	1 = Warning high: Collective power factor	BOOL	FALSE	0	—
QWL_CLPOWFA	1 = Warning low: Collective power factor	BOOL	FALSE	0	—
QE_COMNRDY	1 = Communication with PAC not ready	BOOL	FALSE	0	x
QE_COMFAIL	1 = Communication with PAC failed	BOOL	FALSE	0	x
QE_CRCER	1 = Data invalid (CRC error)	BOOL	FALSE	0	x
QE_FRMER	1 = Data invalid (Frame error)	BOOL	FALSE	0	x
QE_TIMEOUT	1 = Data invalid (Timeout)	BOOL	FALSE	0	x
QE_FMMISMCH	1 = Firmware mismatch	BOOL	FALSE	0	x
QE_VOLTOWER	1 = Voltage overload	BOOL	FALSE	0	x
QE_CUROVER	1 = Current overload	BOOL	FALSE	0	x
QE_PULSOVER	1 = Pulse output overload	BOOL	FALSE	0	x
QE_LIMVIOL	1 = Limit violations	BOOL	FALSE	0	x
QE_OUTNORE	1 = Outputs not remote operated	BOOL	FALSE	0	x
QE_INVLWORK	1 = Invalid value for work/configurable counter	BOOL	FALSE	0	x
QE_INVLENER	1 = Invalid value for energy counter	BOOL	FALSE	0	x
QE_INPRMMET	1 = Invalid parameter value for metering function	BOOL	FALSE	0	x
QE_INPRMLIM	1 = Invalid parameter value for limit violations	BOOL	FALSE	0	x
QMSG_ERR	1 = Message error	BOOL	FALSE	0	—

I/O (parameter)	Comment	Data type	Default	Type	OCM
QMSG_SUP	1 = Message suppression active	BOOL	FALSE	O	x
MSG_STAT1	Message block 1: STATUS output	WORD	0	O	—
MSG_STAT2	Message block 2: STATUS output	WORD	0	O	—
MSG_STAT3	Message block 3: STATUS output	WORD	0	O	—
MSG_STAT4	Message block 4: STATUS output	WORD	0	O	—
MSG_STAT5	Message block 5: STATUS output	WORD	0	O	—
MSG_STAT6	Message block 6: STATUS output	WORD	0	O	—
MSG_ACK1	Message block 1: ACK_STATE output	WORD	0	O	—
MSG_ACK2	Message block 2: ACK_STATE output	WORD	0	O	—
MSG_ACK3	Message block 3: ACK_STATE output	WORD	0	O	—
MSG_ACK4	Message block 4: ACK_STATE output	WORD	0	O	—
MSG_ACK5	Message block 5: ACK_STATE output	WORD	0	O	—
MSG_ACK6	Message block 6: ACK_STATE output	WORD	0	O	—
L1CUR_LID	Current L1 limit ID	WORD	16#FFFF	O	x
L2CUR_LID	Current L2 limit ID	WORD	16#FFFF	O	x
L3CUR_LID	Current L3 limit ID	WORD	16#FFFF	O	x
L1VOLT_LID	Voltage L1 limit ID	WORD	16#FFFF	O	x
L2VOLT_LID	Voltage L2 limit ID	WORD	16#FFFF	O	x
L3VOLT_LID	Voltage L3 limit ID	WORD	16#FFFF	O	x
ACPOW_LID	Active power limit ID	WORD	16#FFFF	O	x
L1POWFA_LID	Power factor a limit ID	WORD	16#FFFF	O	x
L2POWFA_LID	Power factor b limit ID	WORD	16#FFFF	O	x
L3POWFA_LID	Power factor c limit ID	WORD	16#FFFF	O	x
CLPOWFA_LID	Collective power factor limit ID	WORD	16#FFFF	O	x
QUALITY	Quality code of process value	BYTE	0	O	—
O_01	Control bytes DP 0.0-1.7	WORD	0	O	—
MINVALDATE	Last min. values reset date	STRING[10]	—	O	x
MINVALTIME	Last min. values reset time	STRING[8]	—	O	x
MAXVALDATE	Last max. values reset date	STRING[10]	—	O	x
MAXVALTIME	Last max. values reset time	STRING[8]	—	O	x
ENERGYDATE	Last energy counters reset date	STRING[10]	—	O	x
ENERGYTIME	Last energy counters reset time	STRING[8]	—	O	x
STATDIAG	Device diagnostics and status	DWORD	—	O	x
L1VOLT	Voltage ph - n a	REAL	—	O	x
L2VOLT	Voltage ph - n b	REAL	—	O	x
L3VOLT	Voltage ph - n c	REAL	—	O	x
L12VOLT	Voltage ph - ph, a - b	REAL	—	O	x
L23VOLT	Voltage ph - ph, b - c	REAL	—	O	x
L31VOLT	Voltage ph - ph, c - a	REAL	—	O	x
L1CUR	Current a	REAL	—	O	x
L2CUR	Current b	REAL	—	O	x
L3CUR	Current c	REAL	—	O	x

3.2 PAC32DRV/PAC32300 driver block

I/O (parameter)	Comment	Data type	Default	Type	OCM
L1POWFA	Power factor a	REAL	—	O	x
L2POWFA	Power factor b	REAL	—	O	x
L3POWFA	Power factor c	REAL	—	O	x
L1TCUR	THD-R current a	REAL	—	O	x
L2TCUR	THD-R current b	REAL	—	O	x
L3TCUR	THD-R current c	REAL	—	O	x
L1TVOLT	THD-R voltage a	REAL	—	O	x
L2TVOLT	THD-R voltage b	REAL	—	O	x
L3TVOLT	THD-R voltage c	REAL	—	O	x
FREQUENCY	Frequency	REAL	—	O	x
AVGCUR	Average current	REAL	—	O	x
CLAPPOW	Collective apparent power	REAL	—	O	x
CLACPOW	Collective active power	REAL	—	O	x
CLREPOW	Collective reactive power	REAL	—	O	x
CLPOWFA	Collective power factor	REAL	—	O	x
AMPUVOLT	Amplitude unbalance voltage	REAL	—	O	x
AMPUCUR	Amplitude unbalance current	REAL	—	O	x
RLPPL	Real load profile period length	REAL	—	O	x
MAXL1CUR	Max. current a	REAL	—	O	x
MAXL2CUR	Max. current b	REAL	—	O	x
MAXL3CUR	Max. current c	REAL	—	O	x
MINL1CUR	Min. current a	REAL	—	O	x
MINL2CUR	Min. current b	REAL	—	O	x
MINL3CUR	Min. current c	REAL	—	O	x
MAXL1VOLT	Max. voltage ph - n a	REAL	—	O	x
MAXL2VOLT	Max. voltage ph - n b	REAL	—	O	x
MAXL3VOLT	Max. voltage ph - n c	REAL	—	O	x
MAXL12VOLT	Max. voltage ph - ph, a - b	REAL	—	O	x
MAXL23VOLT	Max. voltage ph - ph, b - c	REAL	—	O	x
MAXL31VOLT	Max. voltage ph - ph, c - a	REAL	—	O	x
MINL1VOLT	Min. voltage ph - n a	REAL	—	O	x
MINL2VOLT	Min. voltage ph - n b	REAL	—	O	x
MINL3VOLT	Min. voltage ph - n c	REAL	—	O	x
MINL12VOLT	Min. voltage ph - ph, a - b	REAL	—	O	x
MINL23VOLT	Min. voltage ph - ph, b - c	REAL	—	O	x
MINL31VOLT	Min. voltage ph - ph, c - a	REAL	—	O	x
MAXL1POWFA	Max. power factor a	REAL	—	O	x
MAXL2POWFA	Max. power factor b	REAL	—	O	x
MAXL3POWFA	Max. power factor c	REAL	—	O	x
MAXCLAPPOW	Max. collective apparent power	REAL	—	O	x
MAXCLACPOW	Max. collective active power	REAL	—	O	x
MAXCLREPOW	Max. collective reactive power	REAL	—	O	x

I/O (parameter)	Comment	Data type	Default	Type	OCM
MINL1POWFA	Min. power factor a	REAL	—	O	x
MINL2POWFA	Min. power factor b	REAL	—	O	x
MINL3POWFA	Min. power factor c	REAL	—	O	x
MINCLAPPOW	Min. collective apparent power	REAL	—	O	x
MINCLACPOW	Min. collective active power	REAL	—	O	x
MINCLREPOW	Min. collective reactive power	REAL	—	O	x
MAXL1TVOLT	Max. THD-R voltage a	REAL	—	O	x
MAXL2TVOLT	Max. THD-R voltage b	REAL	—	O	x
MAXL3TVOLT	Max. THD-R voltage c	REAL	—	O	x
MAXL1TCUR	Max. THD-R current a	REAL	—	O	x
MAXL2TCUR	Max. THD-R current b	REAL	—	O	x
MAXL3TCUR	Max. THD-R current c	REAL	—	O	x
AEIT1DW1	Active energy import tariff 1 DWORD1	DWORD	—	O	x
AEIT1DW2	Active energy import tariff 1 DWORD2	DWORD	—	O	x
AEIT2DW1	Active energy import tariff 2 DWORD1	DWORD	—	O	x
AEIT2DW2	Active energy import tariff 2 DWORD2	DWORD	—	O	x
AEET1DW1	Active energy export tariff 1 DWORD1	DWORD	—	O	x
AEET1DW2	Active energy export tariff 1 DWORD2	DWORD	—	O	x
AEET2DW1	Active energy export tariff 2 DWORD1	DWORD	—	O	x
AEET2DW2	Active energy export tariff 2 DWORD2	DWORD	—	O	x
REIT1DW1	Reactive energy import tariff 1 DWORD1	DWORD	—	O	x
REIT1DW2	Reactive energy import tariff 1 DWORD2	DWORD	—	O	x
REIT2DW1	Reactive energy import tariff 2 DWORD1	DWORD	—	O	x
REIT2DW2	Reactive energy import tariff 2 DWORD2	DWORD	—	O	x
REET1DW1	Reactive energy export tariff 1 DWORD1	DWORD	—	O	x
REET1DW2	Reactive energy export tariff 1 DWORD2	DWORD	—	O	x
REET2DW1	Reactive energy export tariff 2 DWORD1	DWORD	—	O	x
REET2DW2	Reactive energy export tariff 2 DWORD2	DWORD	—	O	x
AET1DW1	Apparent energy tariff 1 DWORD1	DWORD	—	O	x
AET1DW2	Apparent energy tariff 1 DWORD2	DWORD	—	O	x
AET2DW1	Apparent energy tariff 2 DWORD1	DWORD	—	O	x
AET2DW2	Apparent energy tariff 2 DWORD2	DWORD	—	O	x

3.2.11 Assignment of block parameters to measured variables

I/O (parameter)	Data type	Measured variable
STATDIAG	DWORD	Device diagnostics and device status
L1VOLT	REAL	Voltage Va-n
L2VOLT	REAL	Voltage Vb-n
L3VOLT	REAL	Voltage Vc-n

I/O (parameter)	Data type	Measured variable
L12VOLT	REAL	Voltage Va-b
L23VOLT	REAL	Voltage Vb-c
L31VOLT	REAL	Voltage Vc-a
L1CUR	REAL	Current a
L2CUR	REAL	Current b
L3CUR	REAL	Current c
L1POWFA	REAL	Power factor a
L2POWFA	REAL	Power factor b
L3POWFA	REAL	Power factor c
L1TCUR	REAL	THD-R current a
L2TCUR	REAL	THD-R current b
L3TCUR	REAL	THD-R current c
L1TVOLT	REAL	THD-R voltage a
L2TVOLT	REAL	THD-R voltage b
L3TVOLT	REAL	THD-R voltage c
FREQUENCY	REAL	Frequency
AVGCUR	REAL	Average current
CLAPPOW	REAL	Total apparent power
CLACPOW	REAL	Total active power
CLREPOW	REAL	Total active power
CLPOWFA	REAL	Total power factor
AMPUVOLT	REAL	Amplitude unbalance - Voltage
AMPUCUR	REAL	Amplitude unbalance - Current
RLPPL	REAL	Demand period
MAXL1CUR	REAL	Maximum current a
MAXL2CUR	REAL	Maximum current b
MAXL3CUR	REAL	Maximum current c
MINL1CUR	REAL	Minimum current a
MINL2CUR	REAL	Minimum current a
MINL3CUR	REAL	Minimum current a
MAXL1VOLT	REAL	Maximum voltage Va-n
MAXL2VOLT	REAL	Maximum voltage Vb-n
MAXL3VOLT	REAL	Maximum voltage Vc-n
MAXL12VOLT	REAL	Maximum voltage Va-b
MAXL23VOLT	REAL	Maximum voltage Vb-c
MAXL31VOLT	REAL	Maximum voltage Vc-a
MINL1VOLT	REAL	Minimum voltage Va-n
MINL2VOLT	REAL	Minimum voltage Vb-n
MINL3VOLT	REAL	Minimum voltage Vc-n
MINL12VOLT	REAL	Minimum voltage Va-b
MINL23VOLT	REAL	Minimum voltage Vb-c
MINL31VOLT	REAL	Minimum voltage Vc-a

I/O (parameter)	Data type	Measured variable
MAXL1POWFA	REAL	Maximum power factor a
MAXL2POWFA	REAL	Maximum power factor b
MAXL3POWFA	REAL	Maximum power factor c
MAXCLAPPOW	REAL	Maximum total apparent power
MAXCLACPOW	REAL	Maximum total active power
MAXCLREPOW	REAL	Maximum total reactive power
MINL1POWFA	REAL	Minimum power factor a
MINL2POWFA	REAL	Minimum power factor b
MINL3POWFA	REAL	Minimum power factor c
MINCLAPPOW	REAL	Minimum total apparent power
MINCLACPOW	REAL	Minimum total active power
MINCLREPOW	REAL	Minimum total reactive power
MAXL1TVOLT	REAL	Maximum THD-R voltage a
MAXL2TVOLT	REAL	Maximum THD-R voltage b
MAXL3TVOLT	REAL	Maximum THD-R voltage c
MAXL1TCUR	REAL	Maximum THD-R current a
MAXL2TCUR	REAL	Maximum THD-R current b
MAXL3TCUR	REAL	Maximum THD-R current c
AEIT1DW1	DWORD	Active energy import tariff 1
AEIT1DW2	DWORD	
AEIT2DW1	DWORD	Active energy import tariff 2
AEIT2DW2	DWORD	
AEET1DW1	DWORD	Active energy export tariff 1
AEET1DW2	DWORD	
AEET2DW1	DWORD	Active energy export tariff 2
AEET2DW2	DWORD	
REIT1DW1	DWORD	Reactive energy import tariff 1
REIT1DW2	DWORD	
REIT2DW1	DWORD	Reactive energy import tariff 2
REIT2DW2	DWORD	
REET1DW1	DWORD	Reactive energy export tariff 1
REET1DW2	DWORD	
REET2DW1	DWORD	Reactive energy export tariff 2
REET2DW2	DWORD	
AET1DW1	DWORD	Apparent energy tariff 1
AET1DW2	DWORD	
AET2DW1	DWORD	Apparent energy tariff 2
AET2DW2	DWORD	

3.2.12 Description of icons and faceplate

Block icon with 3 measured variables

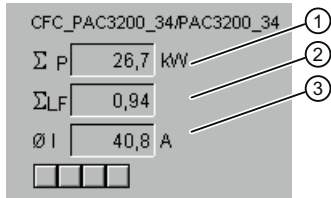

- (1) CLACPOW / unit → CLACPOW#unit
- (2) CLPOWFA
- (3) AVGCUR / unit → AVGCUR#unit

Figure 3-1 Icon with 3 measured variables

Table 3-3 Meanings of the measured variables

Element (parameters)	Meaning
CLACPOW	Total active power
CLPOWFA	Total power factor
AVGCUR	Average current

Block icon without measured variables



Figure 3-2 Icon without measured variables

Faceplate

The faceplate available is described in this chapter.

The following views are available:

Standard with:	Overview	STD_OVERVIEW
	Current/voltage	STD_CURR_VOLT
	Power	STD_POWER
	Power factor	STD_POWER_FAC
	Energy	STD_WORK
	THD	STD_THD
Limits with:	Current	LIMITS_CURR
	Voltage	LIMITS_VOLT
	Power	LIMITS_POWER
	Power factor	LIMITS_POWER_FAC
Units	—	UNITS
Maintenance	—	MAINTENANCE
Messages	—	—
Trend	—	—

The file name is composed as follows:

@PG_PAC32DRV_<view>.PDL / @PG_PAC32300_<view>.PDL

Standard diagrams are used for the views "Messages" and "Trend".

The structure of the individual views of faceplates is described below.

The appearance of the faceplates differ depending on whether the PAC3200 is connected directly to the DP master system or whether it is connected following a Y-link.

When the PAC3200 is connected following a Y-link, no data records can be read because the device following a Y-link switches to DPV0 mode. For this reason the maximum and minimum values for current, voltage, power or power factor and the maximum values for THD-R voltage or THD-R current cannot be read from the device. These measured variables are therefore not indicated in the faceplates.

The faceplates in the figures below are shown for direct connection of PAC3200 to the DP master system.

In the figures, some measured values are highlighted in red or yellow. Limit violations have occurred for these measured values. Yellow indicates that a warning limit has been overshoot or undershot. A measured value with a red background indicates that a limit has been overshoot or undershot.

The limit values are entered in the limits view (LIMITS_XXX). A limit value with the value 0 means that this limit value is not monitored.

The unit prefixes (e.g. kW) for specific measured variables can be set in the units view (UNITS). The display accuracy can be set such that it correlates with the accuracy of the measured variables of the SENTRON PAC3200 (SENTRON PAC4200) Power Monitoring Device.

A list of block parameters or measured variables that is linked into the respective faceplate exists for each faceplate. If a block parameter has units, this is indicated with "/ unit". If the attribute "S7_unit" is used for the units, this is indicated by "→<parameter name>#unit". If this indication is not present, the units from the units view (UNITS) are displayed for this block parameter.

Overview tab sheet (STD_OVERVIEW) for star connection

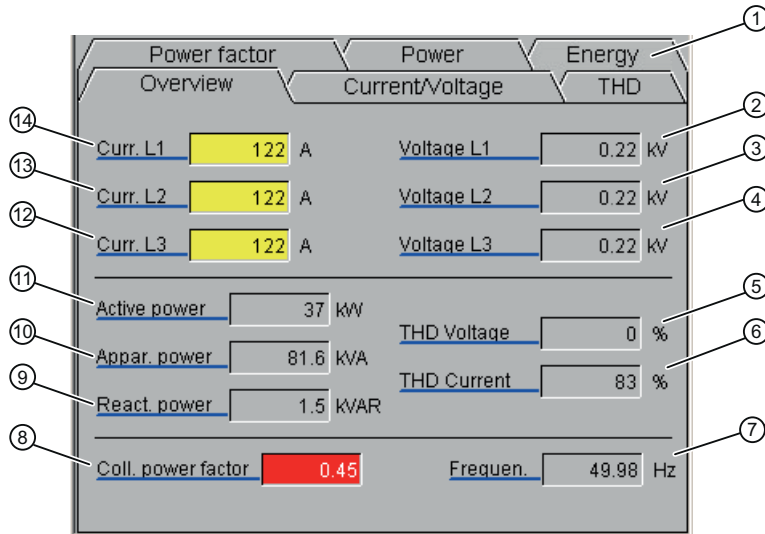

- (1) Tabs for changing the view
- (2) L1VOLT / unit
- (3) L2VOLT / unit
- (4) L3VOLT / unit
- (5) Total harmonic distortion from L1TVOLT, L2TVOLT and L3TVOLT / unit L1TVOLT#unit
- (6) Total harmonic distortion from L1TCUR, L2TCUR and L3TCUR / unit L1TCUR#unit
- (7) FREQUENCY / unit →FREQUENCY#unit
- (8) CLPOWFA / unit →CLPOWFA#unit
- (9) CLREPOW / unit
- (10) CLAPPOW / unit
- (11) CLACPOW / unit
- (12) L3CUR / unit →L3CUR#unit
- (13) L2CUR / unit →L2CUR#unit
- (14) L1CUR / unit →L1CUR#unit

Figure 3-3 Overview faceplate for star connection

Element (parameters)	Meaning	Display when PAC3200 is connected following Y-link
L1CUR	Current a	Yes
L2CUR	Current b	Yes
L3CUR	Current c	Yes
L1VOLT	Voltage V_{a-n}	Yes
L2VOLT	Voltage V_{b-n}	Yes
L3VOLT	Voltage V_{c-n}	Yes
CLACPOW	Total active power	Yes
CLAPPOW	Total apparent power	Yes
CLREPOW	Total reactive power	Yes
CLPOWFA	Total power factor	Yes
Total harmonic distortion from L1TVOLT, L2TVOLT and L3TVOLT	Total harmonic distortion from THD-R voltage L1, THD-R voltage L2 and THD-R voltage L3	Yes
Total harmonic distortion from L1TCUR, L2TCUR and L3TCUR	Total harmonic distortion from THD-R current L1, THD-R current L2 and THD-R current L3	Yes
FREQUENCY	Frequency	Yes

Overview tab sheet (STD_OVERVIEW) for delta connection

With the exception of the elements described here, the overview tab for delta connection corresponds to the overview tab for star connection.

Power factor		Power		Energy	
Overview		Current/Voltage		THD	
<u>Curr. L1</u>	0.30 kA	<u>Voltage L1-2</u>	0.40 kV	(1)	
<u>Curr. L2</u>	0.30 kA	<u>Voltage L2-3</u>	0.40 kV	(2)	
<u>Curr. L3</u>	0.30 kA	<u>Voltage L3-1</u>	0.40 kV	(3)	
<u>Active power</u>	600.00 W	<u>THD voltage</u>	3 %		
<u>Appar. power</u>	600.00 VA	<u>THD current</u>	3 %		
<u>React. power</u>	600.00 VAR				
<u>Coll. power fact.</u>	0.85	<u>Frequency</u>	50.00 Hz		

- (1) L12VOLT / unit
- (2) L23VOLT / unit
- (3) L31VOLT / unit

Figure 3-4 Overview faceplate for delta connection

Element (parameters)	Meaning	Display when PAC3200 is connected following Y-link
L12VOLT	Voltage V _{a-b}	Yes
L23VOLT	Voltage V _{b-c}	Yes
L31VOLT	Voltage V _{c-a}	Yes

Current / voltage tab sheet (STD_CURR_VOLT) for star connection

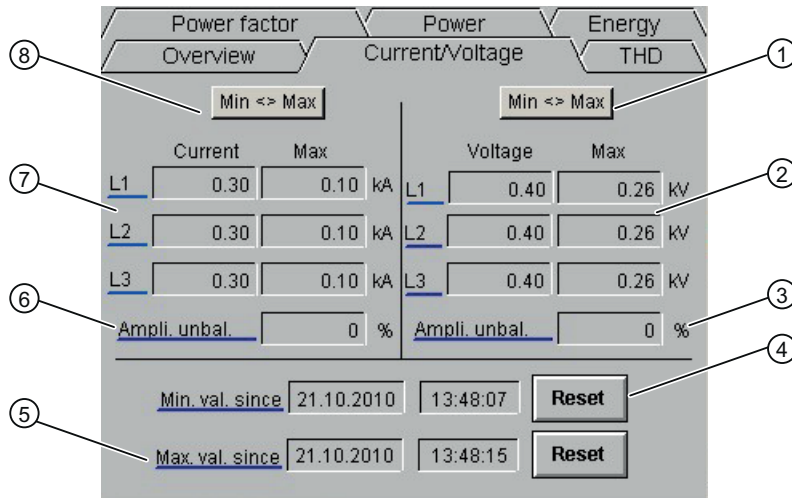

- (1) Button Min <-> Max (voltage)
- (2) L1VOLT, MINL1VOLT <-> MAXL1VOLT
L2VOLT, MINL2VOLT <-> MAXL2VOLT
L3VOLT, MINL3VOLT <-> MAXL3VOLT / unit
- (3) AMPUVOLT / unit → AMPUVOLT#unit
- (4) MINVALDATE, MINVALTIME RESMINVAL
- (5) MAXVALDATE, MAXVALTIME RESMAXVAL
- (6) AMPUCUR / unit → AMPUCUR#unit
- (7) L1CUR, MINL1CUR <-> MAXL1CUR
L2CUR, MINL2CUR <-> MAXL2CUR
L3CUR, MINL3CUR <-> MAXL3CUR / unit
- (8) Button Min <-> Max (current)

Figure 3-5 Current / voltage faceplate for star connection

Element (parameters)	Meaning	Display when PAC3200 is connected following Y-link
L1CUR	Current a	Yes
L2CUR	Current b	Yes
L3CUR	Current c	Yes
Button Min <-> Max (current)	Display changeover between minimum and maximum values	No
MAXL1CUR	Maximum current a	No

Element (parameters)	Meaning	Display when PAC3200 is connected following Y-link
MAXL2CUR	Maximum current b	No
MAXL3CUR	Maximum current c	No
MINL1CUR	Minimum current a	No
MINL2CUR	Minimum current b	No
MINL3CUR	Minimum current c	No
AMPUCUR	Amplitude unbalance - Current	Yes
L1VOLT	Voltage V_{a-n}	Yes
L2VOLT	Voltage V_{b-n}	Yes
L3VOLT	Voltage V_{c-n}	Yes
Button Min <> Max (voltage)	Display changeover between minimum and maximum values	No
MAXL1VOLT	Maximum voltage V_{a-n}	No
MAXL2VOLT	Maximum voltage V_{b-n}	No
MAXL3VOLT	Maximum voltage V_{c-n}	No
MINL1VOLT	Minimum voltage V_{a-n}	No
MINL2VOLT	Minimum voltage V_{b-n}	No
MINL3VOLT	Minimum voltage V_{c-n}	No
AMPUVOLT	Amplitude unbalance - Voltage	Yes
MAXVALDATE, MAXVALTIME RESMAXVAL	Reset the maximum values and indicate the previous reset	Yes
MINVALDATE, MINVALTIME RESMINVAL	Reset the minimum values and indicate the previous reset	Yes

Current / voltage tab sheet (STD_CURR_VOLT) for delta connection

With the exception of the elements described here, the current/voltage tab for delta connection corresponds to the current/voltage tab for star connection.

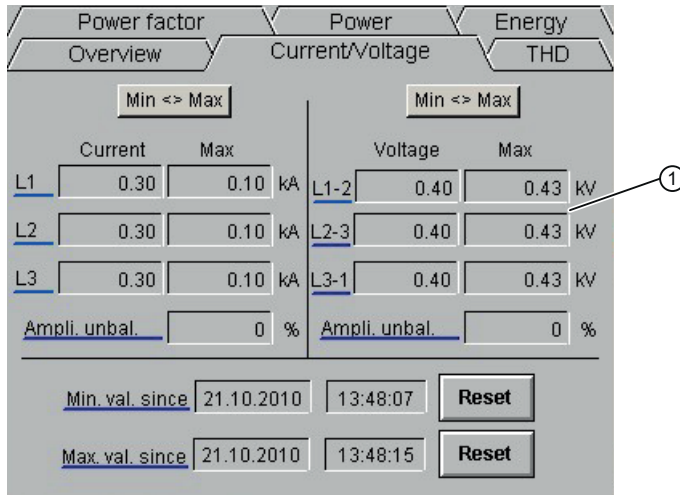

- (1) L12VOLT, MINL12VOLT <> MAXL12VOLT
- L23VOLT, MINL23VOLT <> MAXL23VOLT
- L31VOLT, MINL31VOLT <> MAXL31VOLT / unit

Figure 3-6 Faceplate view current / voltage for delta connection

Element (parameters)	Meaning	Display when PAC3200 is connected following Y-link
L12VOLT	Voltage V_{a-b}	Yes
L23VOLT	Voltage V_{b-c}	Yes
L31VOLT	Voltage V_{c-a}	Yes
MAXL12VOLT	Maximum voltage V_{a-b}	No
MAXL23VOLT	Maximum voltage V_{b-c}	No
MAXL31VOLT	Maximum voltage V_{c-a}	No
MINL12VOLT	Minimum voltage V_{a-b}	No
MINL23VOLT	Minimum voltage V_{b-c}	No
MINL31VOLT	Minimum voltage V_{c-a}	No

Power tab sheet (STD_POWER)

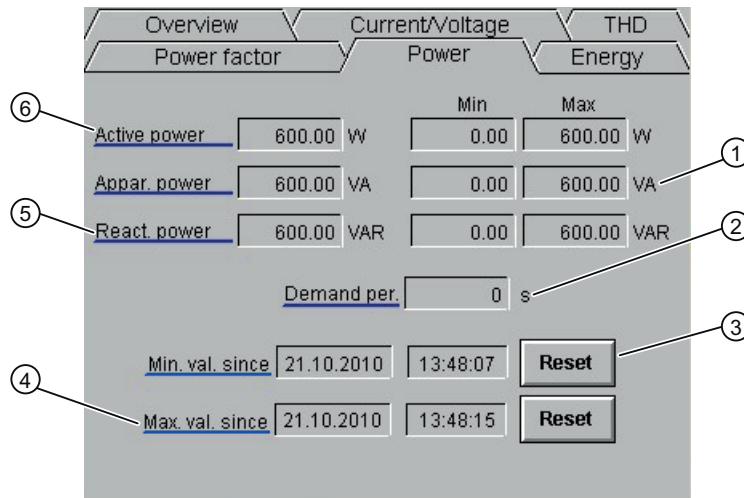

- (1) CLAPPOW, MINCLAPPOW, MAXCLAPPOW / unit
- (2) RLPPPL / unit →RLPPPL#unit
- (3) MINVALDATE, MINVALTIME RESMINVAL
- (4) MAXVALDATE, MAXVALTIME RESMAXVAL
- (5) CLREPOW, MINCLREPOW, MAXCLREPOW / unit
- (6) CLACPOW, MINCLACPOW, MAXCLACPOW / unit

Figure 3-7 Power faceplate

Element (parameters)	Meaning	Display when PAC3200 is connected following Y-link
CLACPOW	Total active power	Yes
CLAPPOW	Total apparent power	Yes
CLREPOW	Total reactive power	Yes
MAXCLACPOW	Maximum total active power	No
MAXCLAPPOW	Maximum total apparent power	No
MAXCLREPOW	Maximum total reactive power	No
MINCLACPOW	Minimum total active power	No
MINCLAPPOW	Minimum total apparent power	No
MINCLREPOW	Minimum total reactive power	No
RLPPPL	Demand period	Yes
MAXVALDATE, MAXVALTIME RESMAXVAL	Reset the maximum values and indicate the previous reset	Yes
MINVALDATE, MINVALTIME RESMINVAL	Reset the minimum values and indicate the previous reset	Yes

Power factor tab sheet (STD_POWER_FAC)

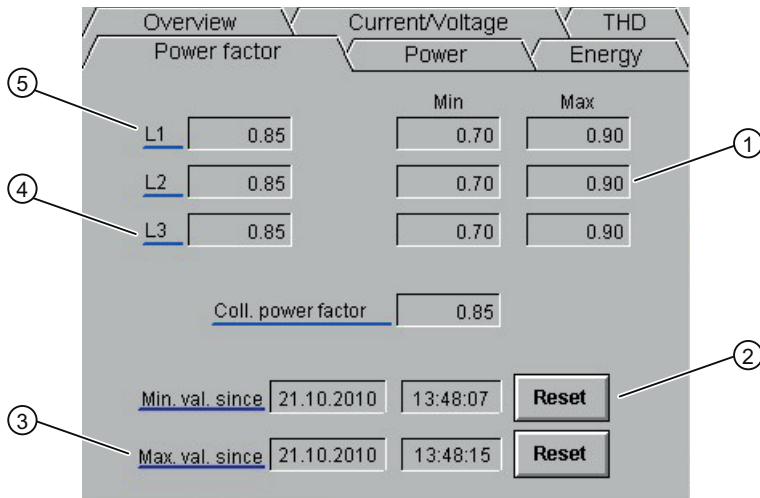

- (1) L2POWFA, MINL2POWFA, MAXL2POWFA
- (2) MINVALDATE, MINVALTIME RESMINVAL
- (3) MAXVALDATE, MAXVALTIME RESMAXVAL
- (4) L3POWFA, MINL3POWFA, MAXL3POWFA
- (5) L1POWFA, MINL1POWFA, MAXL1POWFA

Figure 3-8 Power factor faceplate

Element (parameters)	Meaning	Display when PAC3200 is connected following Y-link
L1POWFA	Power factor a	Yes
L2POWFA	Power factor b	Yes
L3POWFA	Power factor c	Yes
MAXL1POWFA	Maximum power factor a	No
MAXL2POWFA	Maximum power factor b	No
MAXL3POWFA	Maximum power factor c	No
MINL1POWFA	Minimum power factor a	No
MINL2POWFA	Minimum power factor b	No
MINL3POWFA	Minimum power factor c	No
MAXVALDATE, MAXVALTIME RESMAXVAL	Reset the maximum values and indicate the previous reset	Yes
MINVALDATE, MINVALTIME RESMINVAL	Reset the minimum values and indicate the previous reset	Yes

Energy tab sheet (STD_WORK)

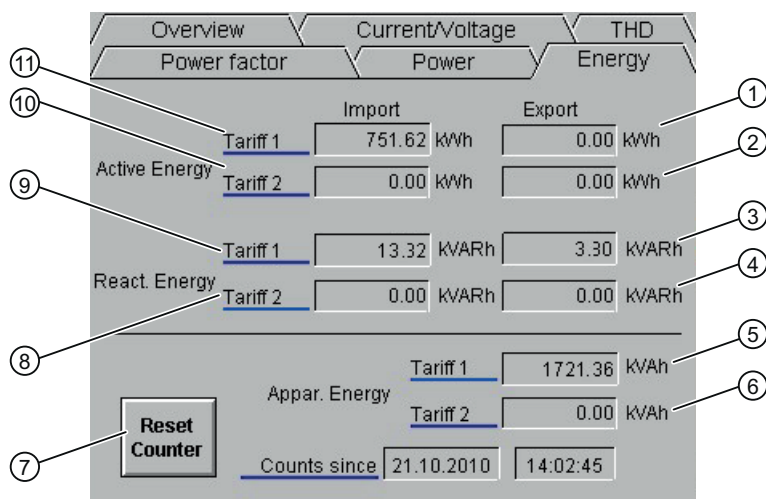

- (1) AEET1DW1/2 / unit
- (2) AEET2DW1/2 / unit
- (3) REET1DW1/2 / unit
- (4) REET2DW1/2 / unit
- (5) AET1DW1/2 / unit
- (6) AET2DW1/2 / unit
- (7) RESENERGY, ENERGYDATE, ENERGYTIME
- (8) REIT2DW1/2 / unit
- (9) REIT1DW1/2 / unit
- (10) AEIT2DW1/2 / unit
- (11) AEIT1DW1/2 / unit

Figure 3-9 Energy faceplate

Element (parameters)	Meaning	Display when PAC3200 is connected following Y-link
AEIT1DW1 / AEIT1DW2	Active energy import tariff 1	No
AEIT2DW1 / AEIT2DW2	Active energy import tariff 2	No
AEET1DW1 / AEET1DW2	Active energy export tariff 1	No
AEET2DW1 / AEET2DW2	Active energy export tariff 2	No
REIT1DW1 / REIT1DW2	Reactive energy import tariff 1	No
REIT2DW1 / REIT2DW2	Reactive energy import tariff 2	No
REET1DW1 / REET1DW2	Reactive energy export tariff 1	No
REET2DW1 / REET2DW2	Reactive energy export tariff 2	No
AET1DW1 / AET1DW2	Apparent energy tariff 1	No
AET2DW1 / AET2DW2	Apparent energy tariff 2	No
RESENERGY, ENERGYDATE, ENERGYTIME	Reset the energy counters and indicate the previous reset	No

THD (STD_THD)

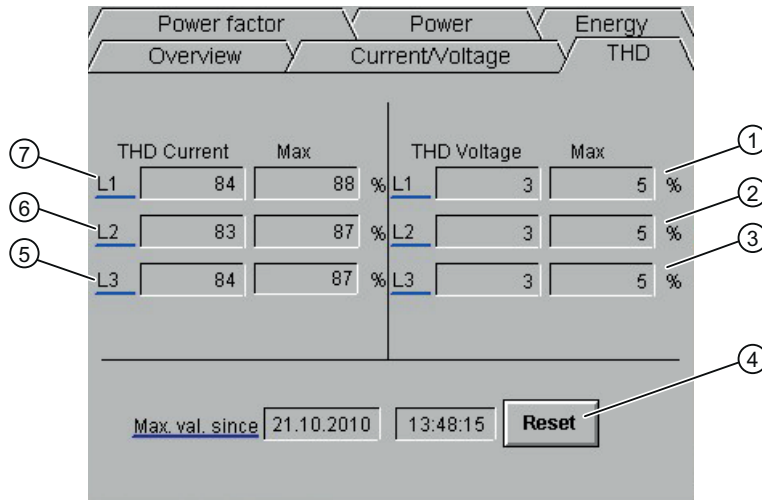

- (1) L1TVOLT / unit → L1TVOLT#unit, MAXL1TVOLT / unit → MAXL1TVOLT#unit
- (2) L2TVOLT / unit → L2TVOLT#unit, MAXL2TVOLT / unit → MAXL2TVOLT#unit
- (3) L3TVOLT / unit → L3TVOLT#unit, MAXL3TVOLT / unit → MAXL3TVOLT#unit
- (4) MAXVALDATE, MAXVALTIME RESMAXVAL
- (5) L3TCUR / unit → L3TCUR#unit, MAXL3TCUR / unit → MAXL3TCUR#unit
- (6) L2TCUR / unit → L2TCUR#unit, MAXL2TCUR / unit → MAXL2TCUR#unit
- (7) L1TCUR / unit → L1TCUR#unit, MAXL1TCUR / unit → MAXL1TCUR#unit

Figure 3-10 Total harmonic distortion faceplate

Element (parameters)	Meaning	Display when PAC3200 is connected following Y-link
L1TCUR	THD-R current a	Yes
L2TCUR	THD-R current b	Yes
L3TCUR	THD-R current c	Yes
MAXL1TCUR	Maximum THD-R current a	No
MAXL2TCUR	Maximum THD-R current b	No
MAXL3TCUR	Maximum THD-R current c	No
L1TVOLT	THD-R voltage a	Yes
L2TVOLT	THD-R voltage b	Yes
L3TVOLT	THD-R voltage c	Yes
MAXL1TVOLT	Maximum THD-R voltage a	No
MAXL2TVOLT	Maximum THD-R voltage b	No
MAXL3TVOLT	Maximum THD-R voltage c	No
MAXVALDATE, MAXVALTIME RESMAXVAL	Reset the maximum values and indicate the previous reset	Yes

The THD-R values on SENTRON PAC4200 must be interpreted in the same way as THD.

Limits – Current tab sheet (LIMITS_CURR)

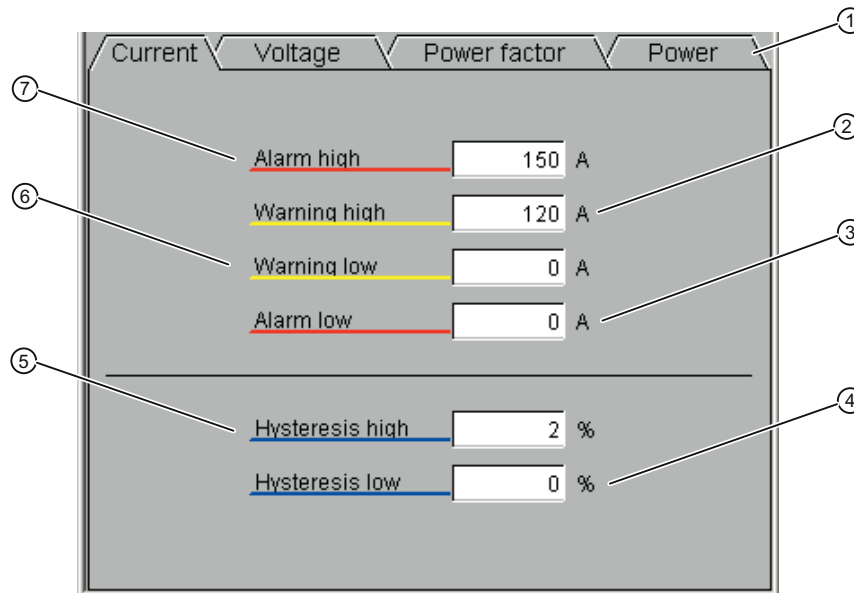

- (1) Tabs for changing the view
- (2) CUR_HW / unit → CUR_HW#unit
- (3) CUR_LL / unit → CUR_LL#unit
- (4) CUR_LLHS / unit → CUR_LLHS#unit
- (5) CUR_HLHS / unit → CUR_HLHS#unit
- (6) CUR_LW / unit → CUR_LW#unit
- (7) CUR_HL / unit → CUR_HL#unit

Figure 3-11 Current limits faceplate

Element (parameters)	Meaning	Display when PAC3200 is connected following Y-link
CUR_HL	Upper limit for current	Yes
CUR_HW	Upper warning limit for current	Yes
CUR_LW	Lower warning limit for current	Yes
CUR_LL	Lower limit for current	Yes
CUR_HLHS	Hysteresis for upper limit for current	Yes
CUR_LLHS	Hysteresis for lower limit for current	Yes

Voltage limits tab sheet (LIMITS_VOLT)

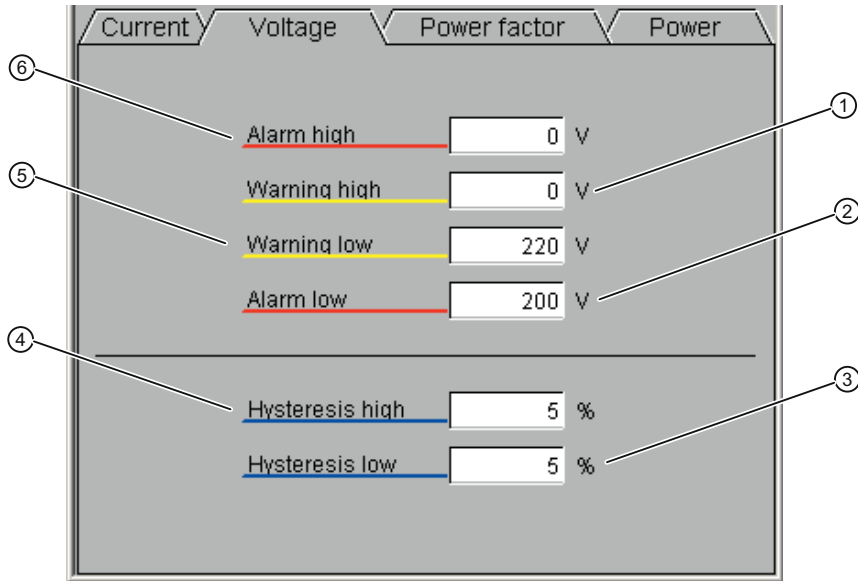

- (1) VOLT_HW / unit →VOLT_HW#unit
- (2) VOLT_LL / unit →VOLT_LL#unit
- (3) VOLT_LLHS / unit →VOLT_LLHS#unit
- (4) VOLT_HLHS / unit →VOLT_HLHS#unit
- (5) VOLT_LW / unit →VOLT_LW#unit
- (6) VOLT_HL / unit →VOLT_HL#unit

Figure 3-12 Voltage limits faceplate

Element (parameters)	Meaning	Display when PAC3200 is connected following Y-link
VOLT_HL	Upper limit for voltage	Yes
VOLT_HW	Upper warning limit for voltage	Yes
VOLT_LW	Lower warning limit for voltage	Yes
VOLT_LL	Lower limit for voltage	Yes
VOLT_HLHS	Hysteresis for upper limit for voltage	Yes
VOLT_LLHS	Hysteresis for lower limit for voltage	Yes

Power limits tab sheet (LIMITS_POWER)

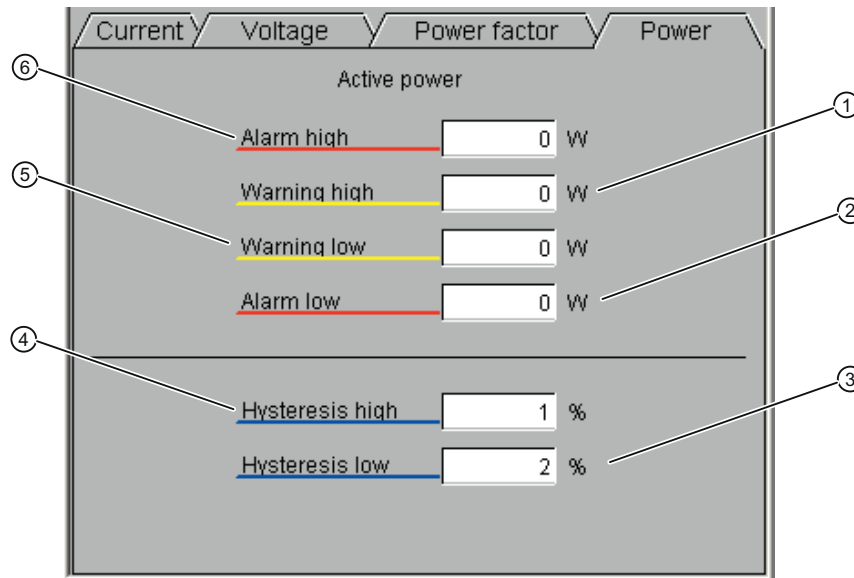

- (1) POW_HW / unit →POW_HW#unit
- (2) POW_LL / unit →POW_LL#unit
- (3) POW_LLHS / unit →POW_LLHS#unit
- (4) POW_HLHS / unit →POW_HLHS#unit
- (5) POW_LW / unit →POW_LW#unit
- (6) POW_HL / unit →POW_HL#unit

Figure 3-13 Power limits faceplate

Element (parameters)	Meaning	Display when PAC3200 is connected following Y-link
POW_HL	Upper limit for active power	Yes
POW_HW	Upper warning limit for active power	Yes
POW_LW	Lower warning limit for active power	Yes
POW_LL	Lower limit for active power	Yes
POW_HLHS	Hysteresis for upper limit for active power	Yes
POW_LLHS	Hysteresis for lower limit for active power	Yes

Power factor limits tab sheet (LIMITS_POWER_FAC)

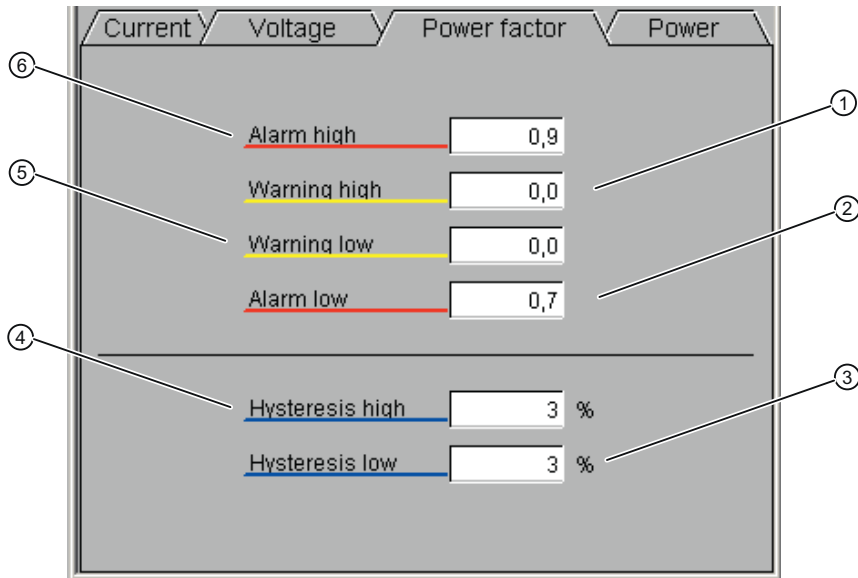

- (1) POWFA_HW
- (2) POWFA_LL
- (3) POWFA_LLHS / unit → POWFA_LLHS#unit
- (4) POWFA_HLHS / unit → POWFA_HLHS#unit
- (5) POWFA_LW
- (6) POWFA_HL

Figure 3-14 Power factor limits faceplate

Element (parameters)	Meaning	Display when PAC3200 is connected following Y-link
POWFA_HL	Upper limit for power factor	Yes
POWFA_HW	Upper warning limit for power factor	Yes
POWFA_LW	Lower warning limit for power factor	Yes
POWFA_LL	Lower limit for power factor	Yes
POWFA_HLHS	Hysteresis for upper limit for power factor	Yes
POWFA_LLHS	Hysteresis for lower limit for power factor	Yes

Units (UNITS)

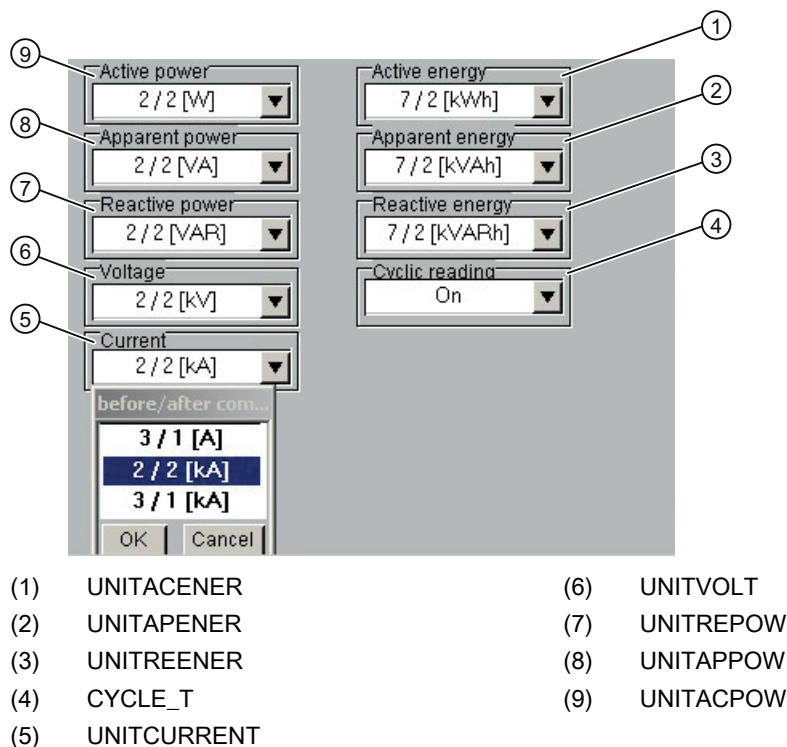

Figure 3-15 Units faceplate

Element (parameters)	Meaning	Display when PAC3200 is connected following Y-link
UNITACPOW	Active power units	Yes
UNITAPPOW	Apparent power units	Yes
UNITREPOW	Reactive power units	Yes
UNITACENER	Active energy units	Yes
UNITAPENER	Apparent energy units	Yes
UNITREENER	Reactive energy units	Yes
UNITCURRENT	Current units	Yes
UNITVOLT	Voltage units	Yes
CYCLE_T	Activation/deactivation of cyclic reading in cycles of 60 seconds	No

Table 3- 4 Possible settings of the combination boxes

Measured variable	Decimal places before/after the point [units]	Measured variable	Decimal places before/after the point [units]
Active power	2 / 2 [W] 3 / 1 [kW] 4 / 0 [kW] 4 / 0 [MW]	Active energy	7 / 2 [kWh] 9 / 0 [kWh] 9 / 0 [MWh] 9 / 0 [GWh]
Apparent power	2 / 2 [VA] 3 / 1 [kVA] 4 / 0 [kVA] 4 / 0 [MVA]	Apparent energy	7 / 2 [kVAh] 9 / 0 [kVAh] 9 / 0 [MVAh] 9 / 0 [GVAh]
Reactive power	2 / 2 [VAR] 3 / 1 [kVAR] 4 / 0 [kVAR] 4 / 0 [MVAR]	Reactive energy	7 / 2 [kVARh] 9 / 0 [kVARh] 9 / 0 [MVARh] 9 / 0 [GVARh]
Voltage	3 / 1 [V] 2 / 2 [kV] 3 / 1 [kV]	Current	3 / 1 [A] 2 / 2 [kA] 3 / 1 [kA]

Maintenance (MAINTENANCE)

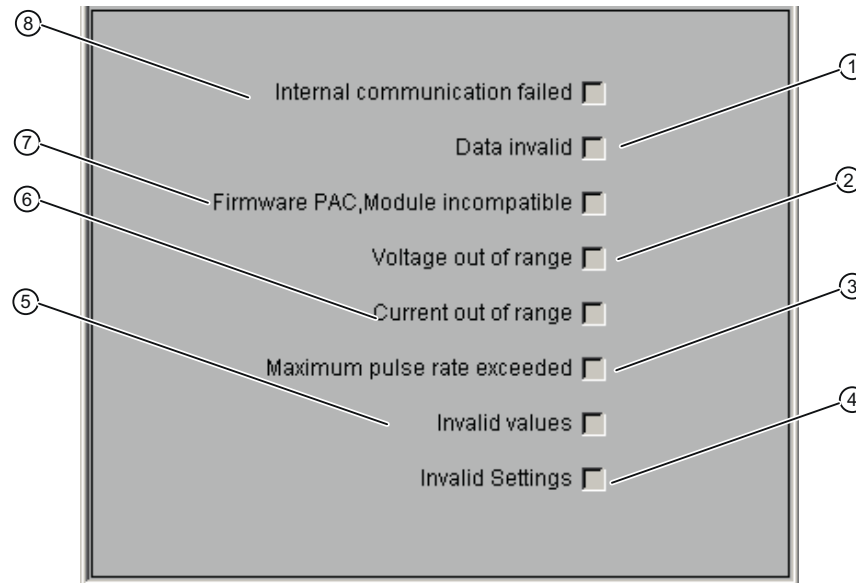

- (1) QE_CRCER or QE_FRMER or QE_TIMEOUT
- (2) QE_VOLTOVER
- (3) QE_PULSOVER
- (4) QE_INPRMMET or QE_INPRMLIM
- (5) QE_INVLWORK or QE_INVLENER
- (6) QE_CUOVER
- (7) QE_FMMISMCH
- (8) QE_COMNRDY or QE_COMFAIL

Figure 3-16 Maintenance faceplate

Element (parameters)	Meaning	Display when PAC3200 is connected following Y-link
QE_COMNRDY	Internal communication is faulty	Yes
QE_COMFAIL	Internal communication is faulty	Yes
QE_CRCER	Data invalid	Yes
QE_FRMER	Data invalid	Yes
QE_TIMEOUT	Data invalid	Yes
QE_FMMISMCH	Firmware PAC, Module incompatible	Yes
QE_VOLTOVER	Voltage out of range	Yes
QE_CUOVER	Current out of range	Yes
QE_PULSOVER	Maximum pulse rate exceeded	Yes
QE_INVLWORK	Invalid values	Yes
QE_INVLENER	Invalid values	Yes
QE_INPRMMET	Invalid settings	Yes
QE_INPRMLIM	Invalid settings	Yes

Configuring guide

4.1 Configuring a measuring point

4.1.1 Creating the S7 program

The library is divided into a program folder for S7-300 and a program folder for S7-400 that contain the standard blocks and a sample program that can be used as a template.

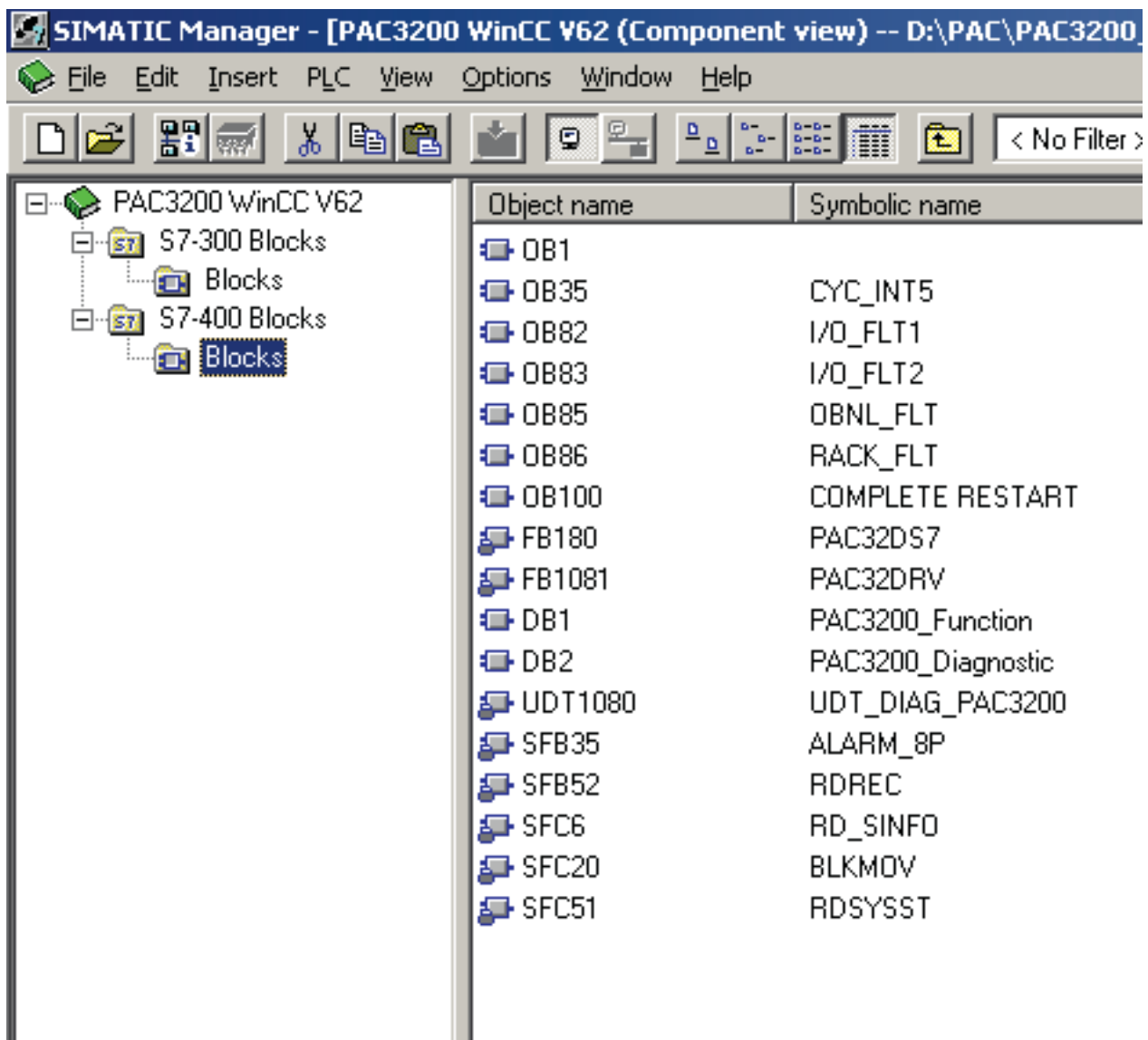

Figure 4-1 Library in the SIMATIC Manager

The sample programs in S7-300 and S7-400 are structured identically. The sample program for S7-400 is described on the following pages. For the S7-300 sample program, only the differences to S7-400 are explained.

The sample blocks and the procedure for creating the program are described below.

Structure of the sample program

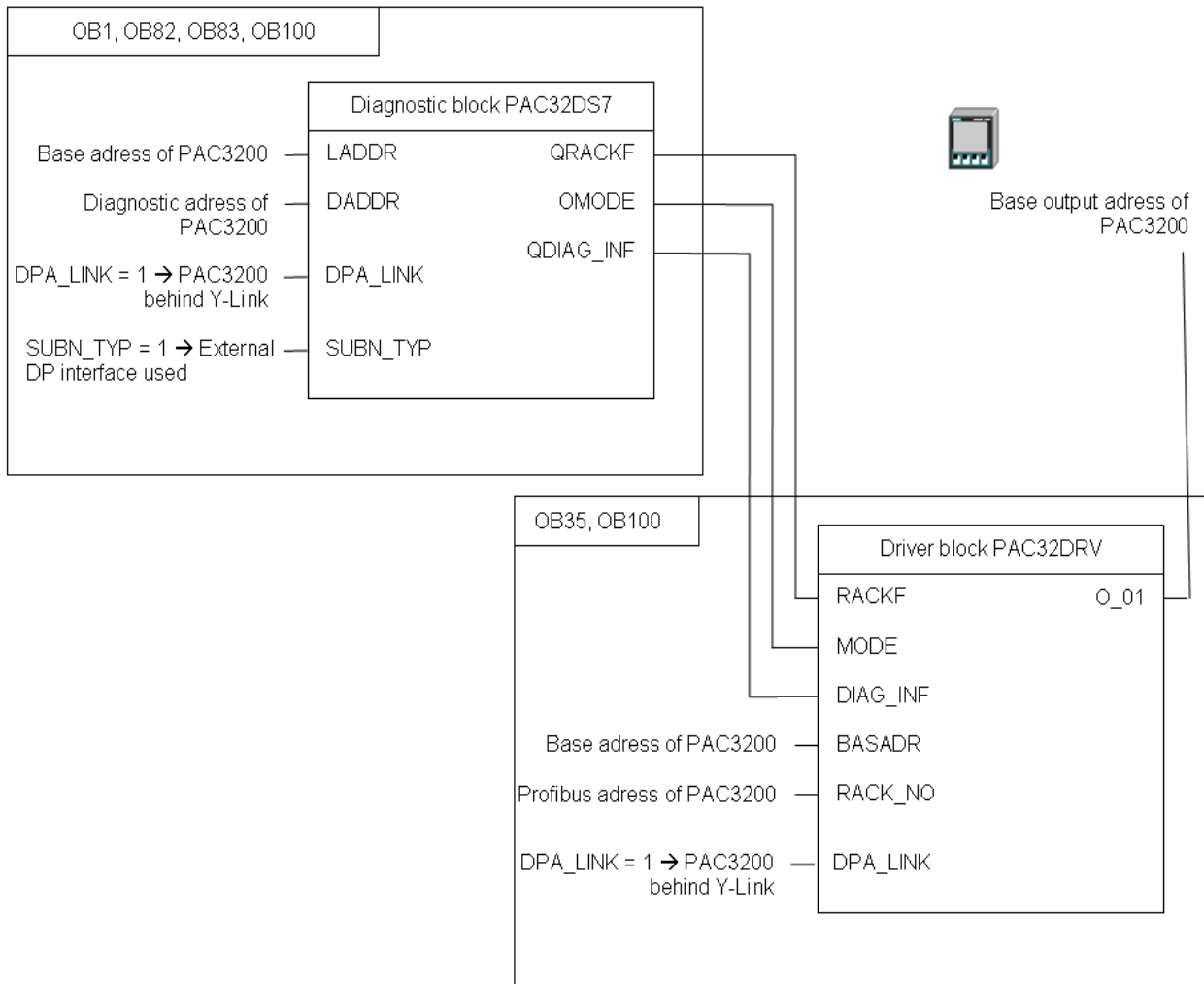

Figure 4-2 Structure of the sample program

The diagnostic block PAC32DS7 is called in OB1, OB82, OB83 and OB100. The parameterization of the diagnostic block is included in OB1.

OB1

Network 1: Diagnostic block

Comment:

```
CALL "PAC32DS7" , "PAC3200_Diagnostic"  
LADDR    :=512                //Base adress of PAC3200 module  
DADDR    :=8189               //Diagnostic adress of PAC3200 module  
DPA_LINK :=FALSE              //Device connection = DP Master  
SUBN_TYP :=FALSE              //Internal DP-Interface  
QERR     :=  
QRACKF   :=  
DEACTIV  :=  
SFC_ERR  :=  
SFC_FLT  :=  
OMODE    :=  
QDIAG_INF:=
```

Figure 4-3 Call of the diagnostic block in OB1

At the parameter input...

- LADDR, the logic start address of the PAC3200 is parameterized.
- DADDR, the diagnostic address of the PAC3200 is parameterized.
- DPA_LINK you determine whether the PAC3200 is operated following a Y-link (DPA_LINK = 1 → PAC3200 following a DP / PA link)
- SUBN_TYP you determine whether the PAC3200 is located on an external DP interface such as an IM467 (SUBN_TYP = 1 → DP slave on external DP interface).

OB35

```

Network 1: Function block
Comment:

CALL "PAC32DRV" , "PAC3200_Function"
MODE      := "PAC3200_Diagnostic".OMODE
BASADR    := 512 //Base address of PAC3200 module
RACK_NO   := 6 //Profibus address of PAC3200 module
RACKF     := "PAC3200_Diagnostic".QRACKF
DIAG_INF  := "PAC3200_Diagnostic".QDIAG_INF
DPA_LINK  := FALSE //Device connection = DP Master
SIM_ON    :=
SIM_CUR   :=
SIM_VOLT  :=
SIM_POW   :=
SIM_POWFAC :=
SIM_DWIENER:=
SIM_DWZENER:=
STRDLTCH := FALSE
UNITVOLT  :=
UNITCURRENT:=
UNITACPOW :=
UNITAPPOW :=
UNITREPOW :=
UNITACENER :=
UNITAPENER :=
UNITREENER :=
SAMPLE_T := #sample_t
CYCLE_T  :=
RUNUPCYC := 10
MSG_EVID1 := DW#16#A
MSG_EVID2 := DW#16#B
MSG_EVID3 := DW#16#C
MSG_EVID4 := DW#16#D
MSG_EVID5 := DW#16#E
MSG_EVID6 := DW#16#F
MSG_EVID7 := DW#16#10
MSG_EVID8 := DW#16#11
MSG_EVID9 := DW#16#12
EN_RDWR  :=
CYCLIC   := TRUE
    
```

Figure 4-4 Call of the driver block in OB35 (S7-400)

The driver block PAC32DRV is called in OB35 and OB100. The parameterization and interconnection of the driver block is included in OB35.

At the parameter input...

- RACK_NO, the rack number (PROFIBUS address) of the PAC3200 is parameterized.
- BASADR, the start address of the PAC3200 is parameterized.
- DPA_LINK you determine whether the PAC3200 is operated following a Y-link (DPA_LINK = 1 → PAC3200 following a DP / PA link)
- STRDLTCH you determine whether the voltage for delta connection is displayed in the faceplate (STRDLTCH = 1 → delta connection)

The parameter input...

- MODE is interconnected with the output OMODE of the diagnostic block PAC32DS7.
- RACKF is interconnected with the output QRACKF of the diagnostic block PAC32DS7.
- DIAG_INF is interconnected with the output QDIAG_INF of the diagnostic block PAC32DS7.

The parameter output O_01 is connected to the start output address of the PAC3200.

S7-300

On the S7-300, the call of the diagnostic block PAC32DS7 can be omitted in OB83. The PAC32300 block is used as the driver block. When parameterizing the driver block in OB35 the parameter DPA_LINK is omitted.

Network 2: Function block

Comment:

```
CALL "PAC32300" , "PAC3200_Function"
MODE      := "PAC3200_Diagnostic".OMODE
BASADR    := 256 //Base address of PAC3200 module
RACK_NO   := B#16#6 //Profibus adress of PAC3200 module
RACKF     := "PAC3200_Diagnostic".QRACKF
DIAG_INF  := "PAC3200_Diagnostic".QDIAG_INF
SIM_ON    :=
SIM_CUR   :=
SIM_VOLT  :=
SIM_POW   :=
SIM_POWFAC :=
SIM_DW1ENER :=
SIM_DW2ENER :=
STRDLTCH := FALSE
UNITVOLT  :=
UNITACPOW :=
UNITAPPOW :=
UNITREPOW :=
UNITACENER :=
UNITAPENER :=
UNITREENER :=
SAMPLE_T  := #sample_t
CYCLE_T   :=
RUNUPCYC := 10
MSG_EVID1 := DW#16#60000001
MSG_EVID2 := DW#16#60000002
MSG_EVID3 := DW#16#60000003
MSG_EVID4 := DW#16#60000004
MSG_EVID5 := DW#16#60000005
MSG_EVID6 := DW#16#60000006
CHP_ID    :=
EN_RDWR   :=
MSG_LOCK  :=
L3POWFA_LID :=
CLPOWFA_LID :=
QUALITY   :=
O_01      := AW256 //Base output adress of PAC3200
MINVALDATE :=
MINVALTIME :=
MAXVALDATE :=
```

Figure 4-5 Call of the driver block in OB35 (S7-300)

4.1.2 Connection to WinCC

After the S7 program has been created, the driver block can be connected to WinCC.

- You are recommended to create the variables and messages using AS-OS engineering in WinCC. This requires integration of the WinCC project into STEP 7. For the variables and messages to be created in WinCC, the instance data block of the driver block that can be operated and monitored (in the sample program, this is DB1 with the symbolic name PAC3200_Function) must receive the object property "Operator control and monitoring".

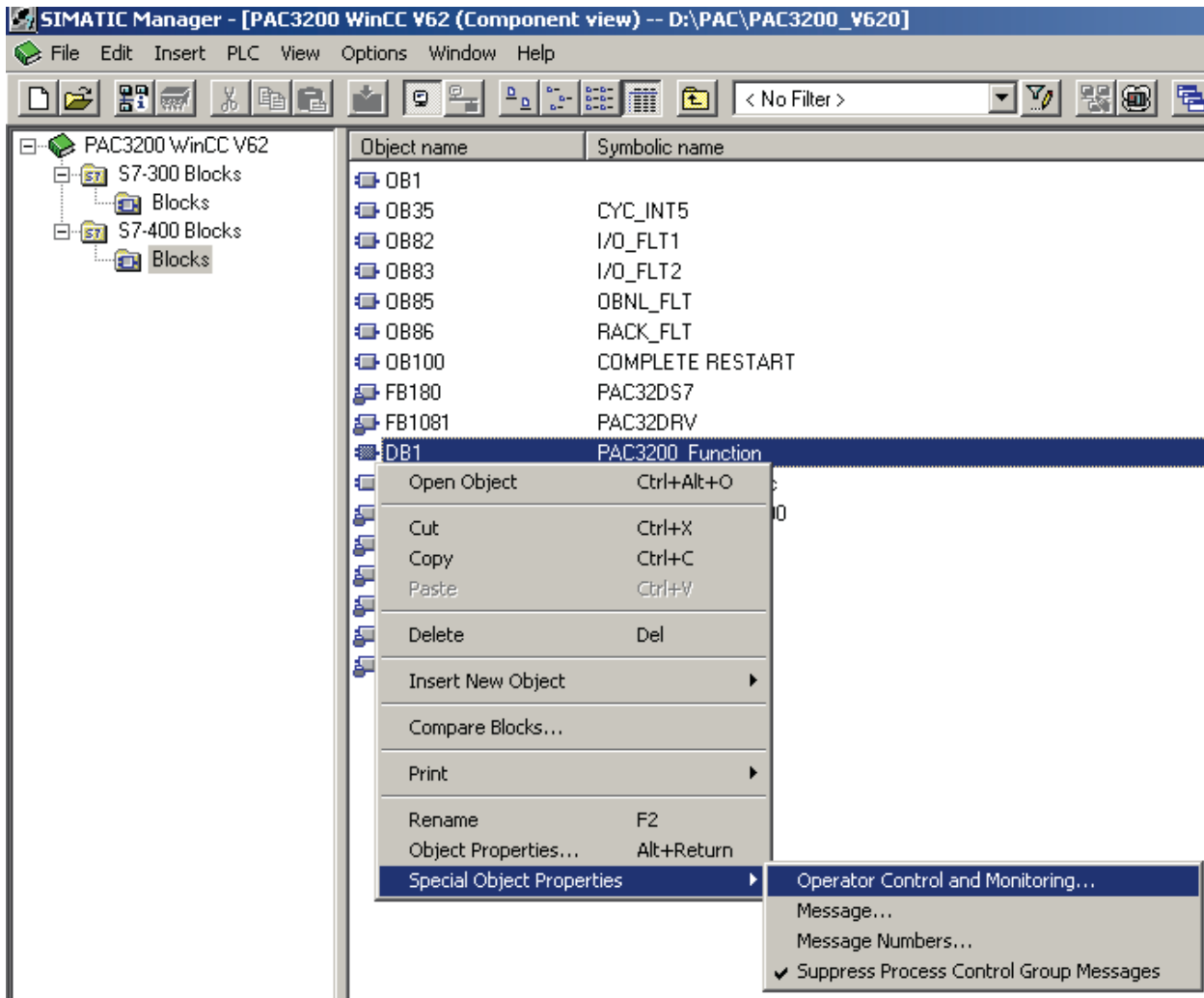

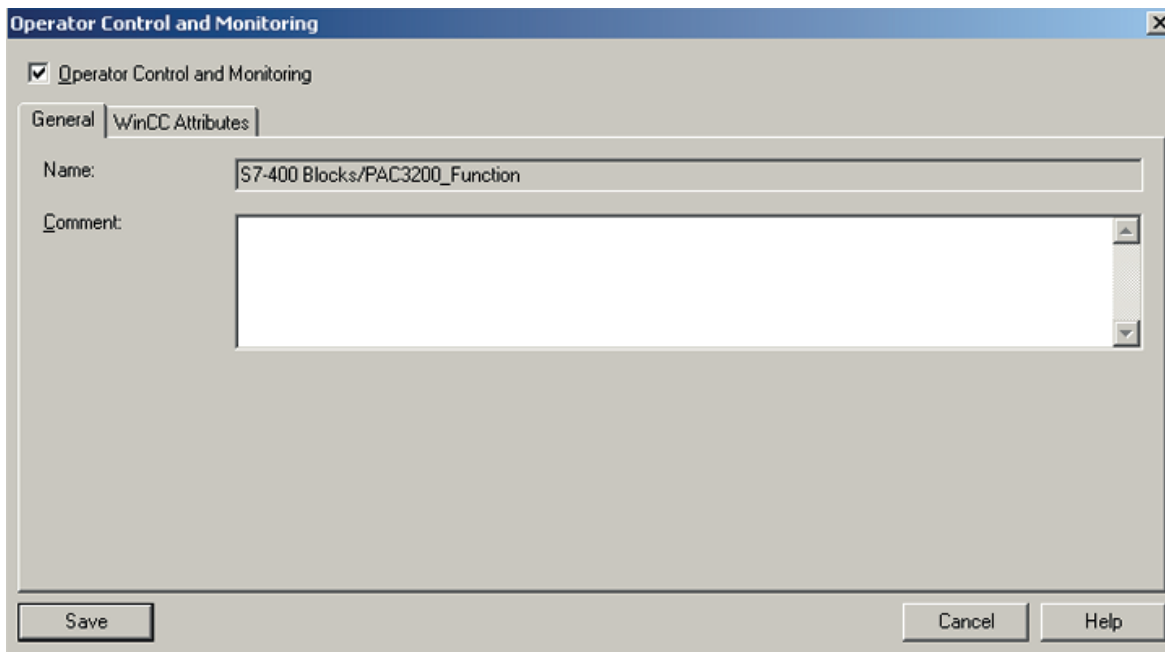

Figure 4-6 Property operator control and monitoring of the DB1

- Use the following WinCC program parts for configuring the process control options:
 - "OS project editor"
 - "Picture tree manager"
- Manually copy the user object from file @Template_PAC32DRV.pdl to process display and run Dynamic Wizard "Connect Faceplate to Measuring Point"
The wizard only becomes visible when the user object has been selected.

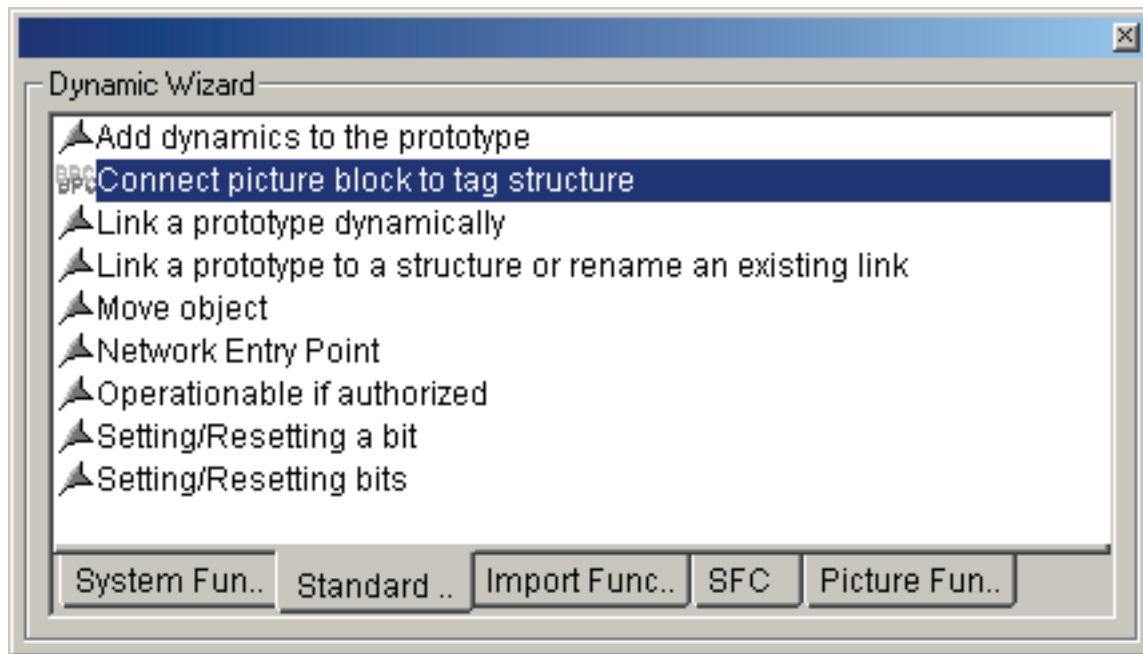

Figure 4-7 Link picture component with measuring point

Technical data

The following meanings apply:

Block type name

The symbolic identifier in the library's icon table for the relevant FB. It must be unique to the project.

Object name

Consists of the type of block (FB) and the number.

Block length in load/work memory

Memory requirement of program code, once per block type.

Length of instance data in load/work memory

Memory requirement of an instance DB.

Temporary memory

The local data memory needed when calling the block in an execution level. This is limited depending on the CPU. If exceeded, you must check this in the CPU configuration and, if necessary, redistribute to OBs of the size actually needed.

Called blocks

The blocks stated here are used by the block in question and must be located in the user program. They are saved in the same library.

Block (type name)	Number	Block length in load / work memory (bytes)	Length of instance data in load / work memory (bytes)	Temporary memory (bytes)	Called blocks
PAC32DS7	180	1530 / 1198	320 / 80	96	UDT1080 SFC6 SFC51
PAC32300	181	44232 / 38990	2258 / 1080	78	UDT1080 SFB52 SFC6 SFC19 SFC20 SFC107
PAC42300	182	47070 / 41584	2540 / 1306	80	UDT1081 SFB52 SFB53 SFC6 SFC19 SFC20 SFC107
PAC32DRV	1081	27950 / 24362	3906 / 2284	66	UDT1080 SFB35 SFB52 SFC6 SFC20
PAC42DRV	1082	30784 / 26954	4182 / 2506	68	UDT1081 SFB35 SFB52 SFB53 SFC6 SFC20

The values indicated in the table are simply intended as a guide. The actual values may deviate slightly.

Technical Support

6.1 Technical Support

For further assistance, refer to

Technical Support on the Internet:

Internet address of Technical Support
(<http://www.siemens.com/lowvoltage/technical-support>)

Index

T

Technical Support, 75

